



AMCA International

Fan Energy Regulations & Impact on Fan Selection

Mike Wolf, P.E.

mike.wolf@greenheck.com

Air System Engineering & Technology (ASET) Conference–US

San Antonio, TX • Hyatt Regency San Antonio Riverwalk • March 6 - 7, 2018

Professional Development Hours (PDH) Certificates

The Air Movement and Control Association International (AMCA), has met the standards and requirements of the Registered Continuing Education Providers Program. Credit earned on completion of this program will be reported to the RCEP. A certificate of completion will be issued to each participant. As such, it does not include content that may be deemed or construed to be an approval or endorsement by NCEES or RCEP.

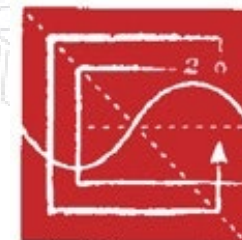

NCEES



Copyright Materials

This educational activity is protected by U.S. and International copyright laws. Reproduction, distribution, display, and use of the educational activity without written permission of the presenter is prohibited.

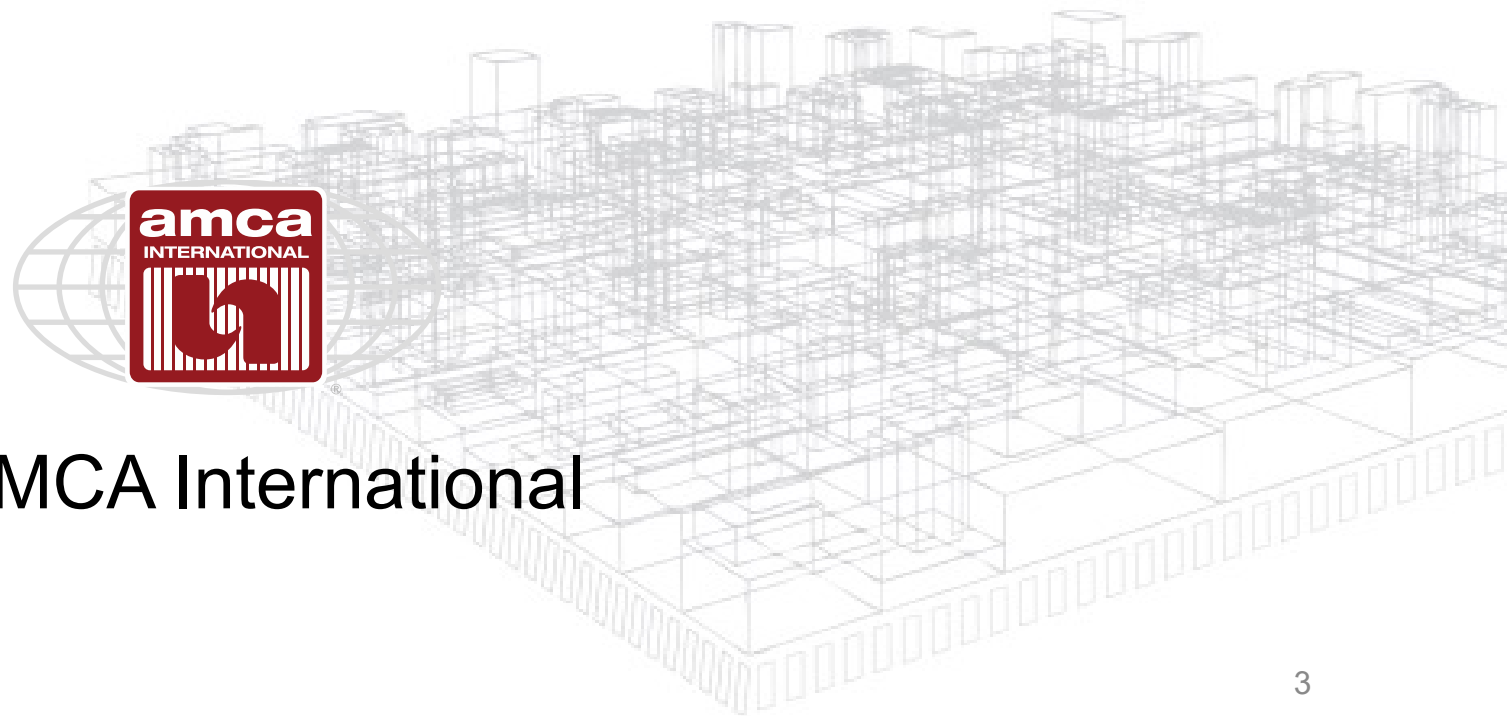

© AMCA International

Learning Objectives

- Basics of Legislation, Regulations, Rules, Standards & Codes
- Compare Fan Energy Regulation Metrics
 - Fan Efficiency Grades (FEG)
 - Fan Energy Index (FEI)

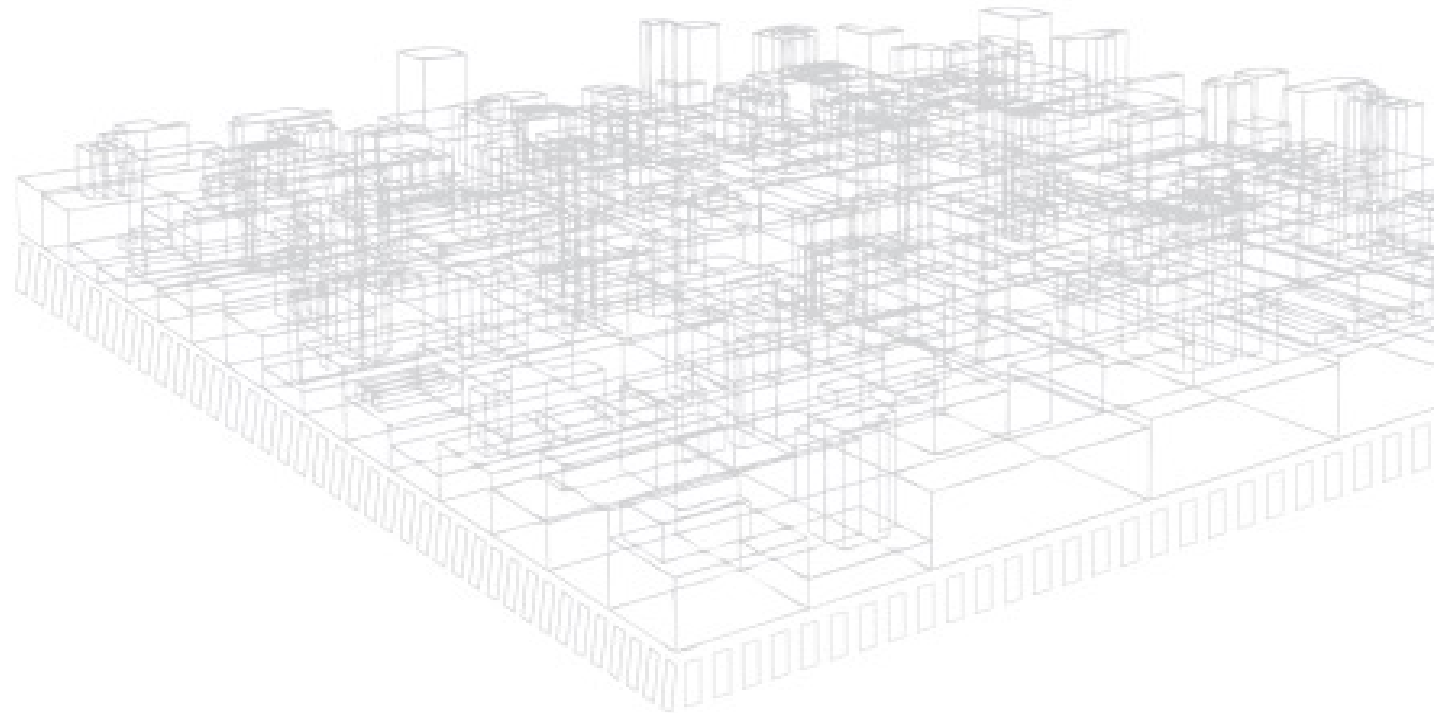



Energy Regulation Trivia...

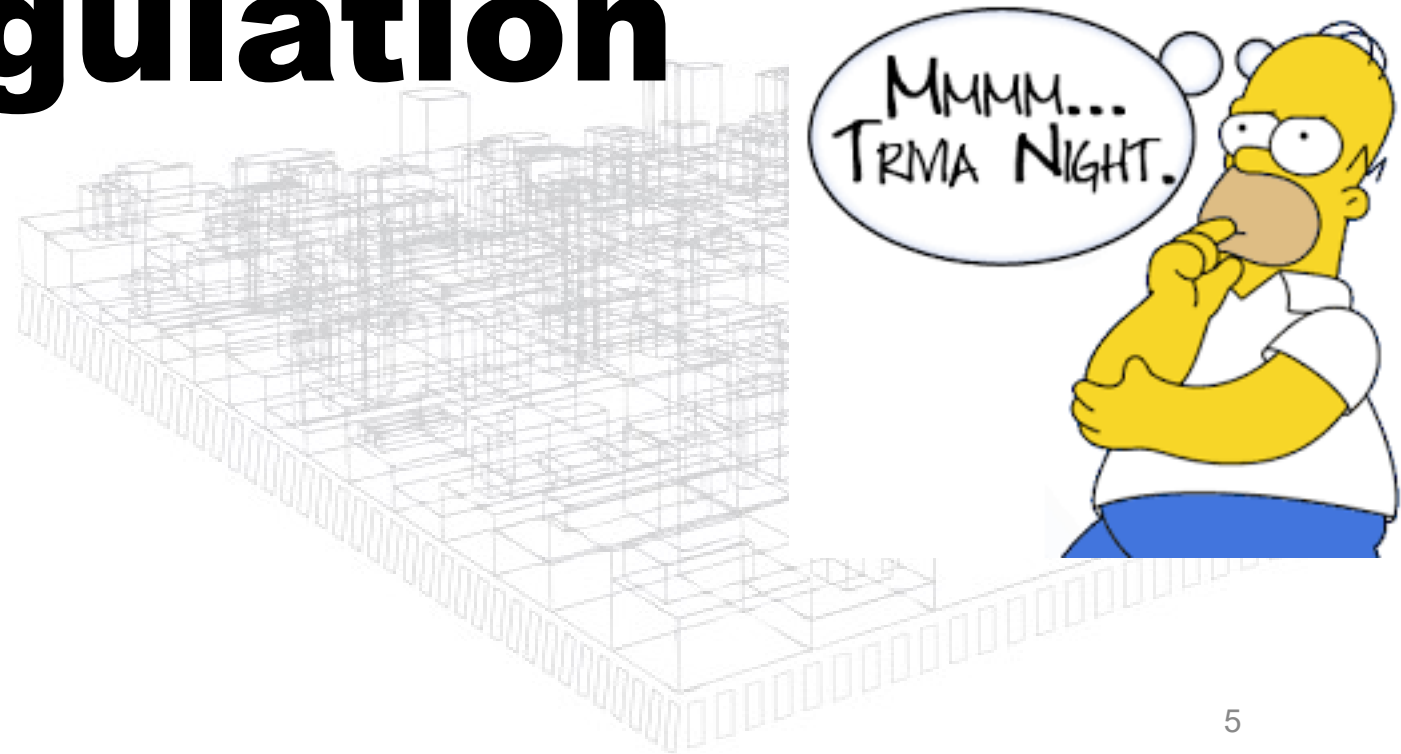

What event & act of congress initiated today's U.S. energy regulation?

- ***Organization of Petroleum Exporting Countries(OPEC) Oil Embargo (1973)***
- ***38th President Gerald Ford (Republican) signed Energy Policy & Conservation Act of 1975 (EPCA)***
- ***US DOE established August 1977***



U.S. DEPARTMENT OF
ENERGY

What is a Quad?

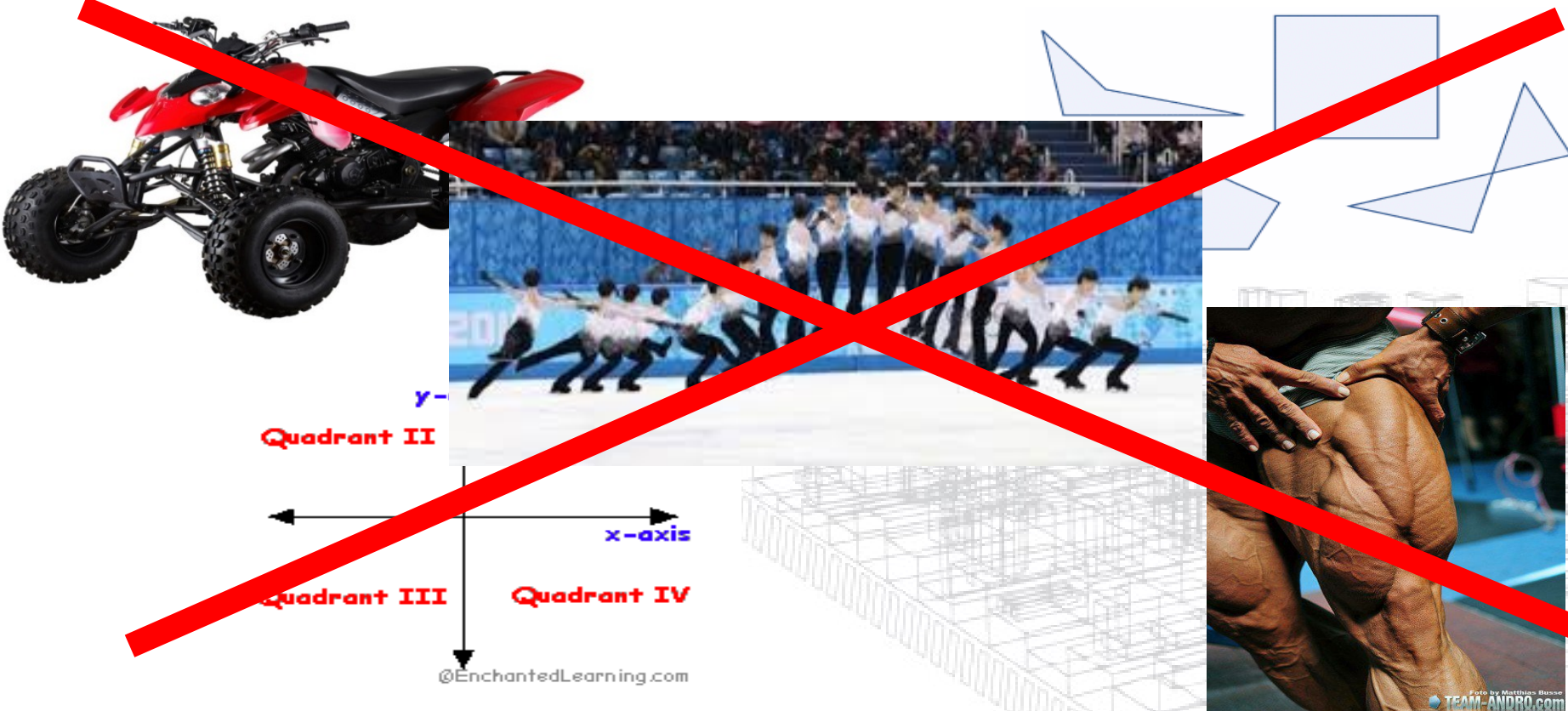

A Quad is* ...

1,000,000,000,000,000 BTU *or ... 10 Billion, 100,000
BTU Residential Furnaces*



293,297,222,222 kWh *or ... 293.3 Million 100 W Light Bulbs*



83,333,333,333 Tons of AC *or ... 16 Billion 5.2 Ton
Residential AC Units*



*Presenter is not responsible for conversions.

How many Quads of energy does the U.S. consume annually?

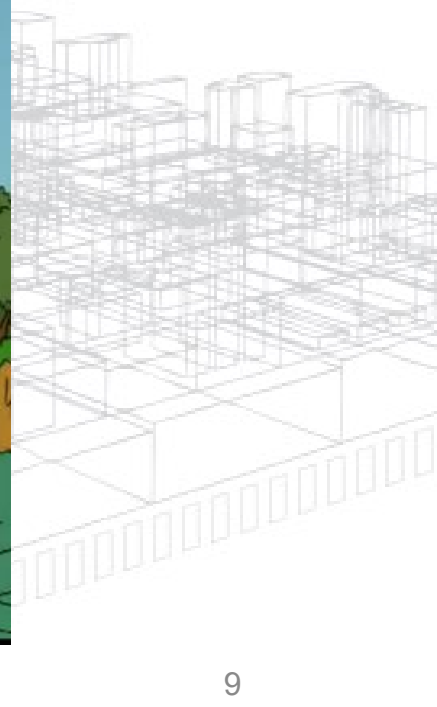



Share of total U.S. energy consumed by major sectors of the economy, 2014

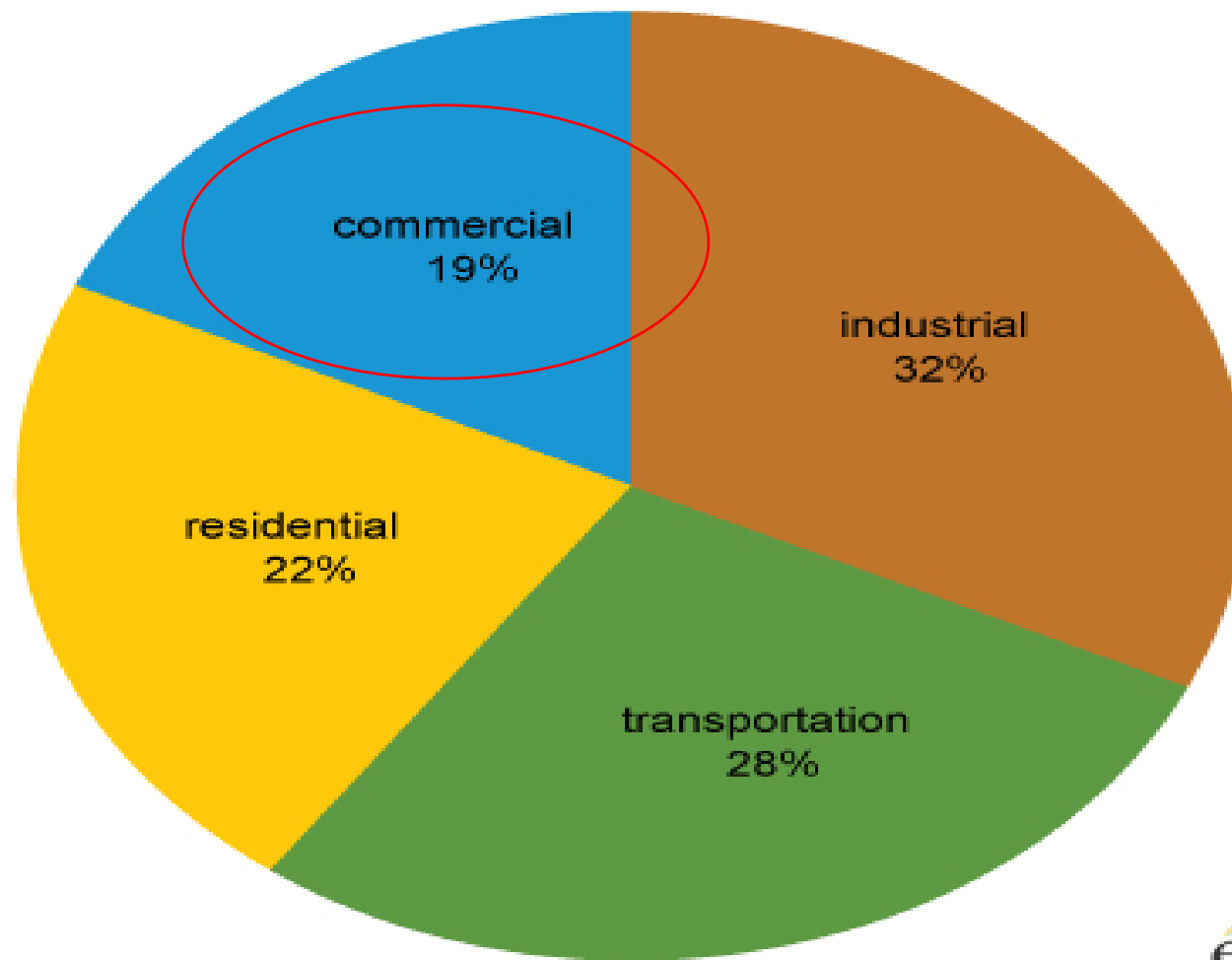

**United States
Annual Energy
Consumption =
100 Quads**

Note: Sum of individual percentages may not equal 100 because of independent rounding.

Source: U.S. Energy Information Administration, *Monthly Energy Review*, Table 2.1 (March 2015), preliminary data for 2014

Commercial Building Energy

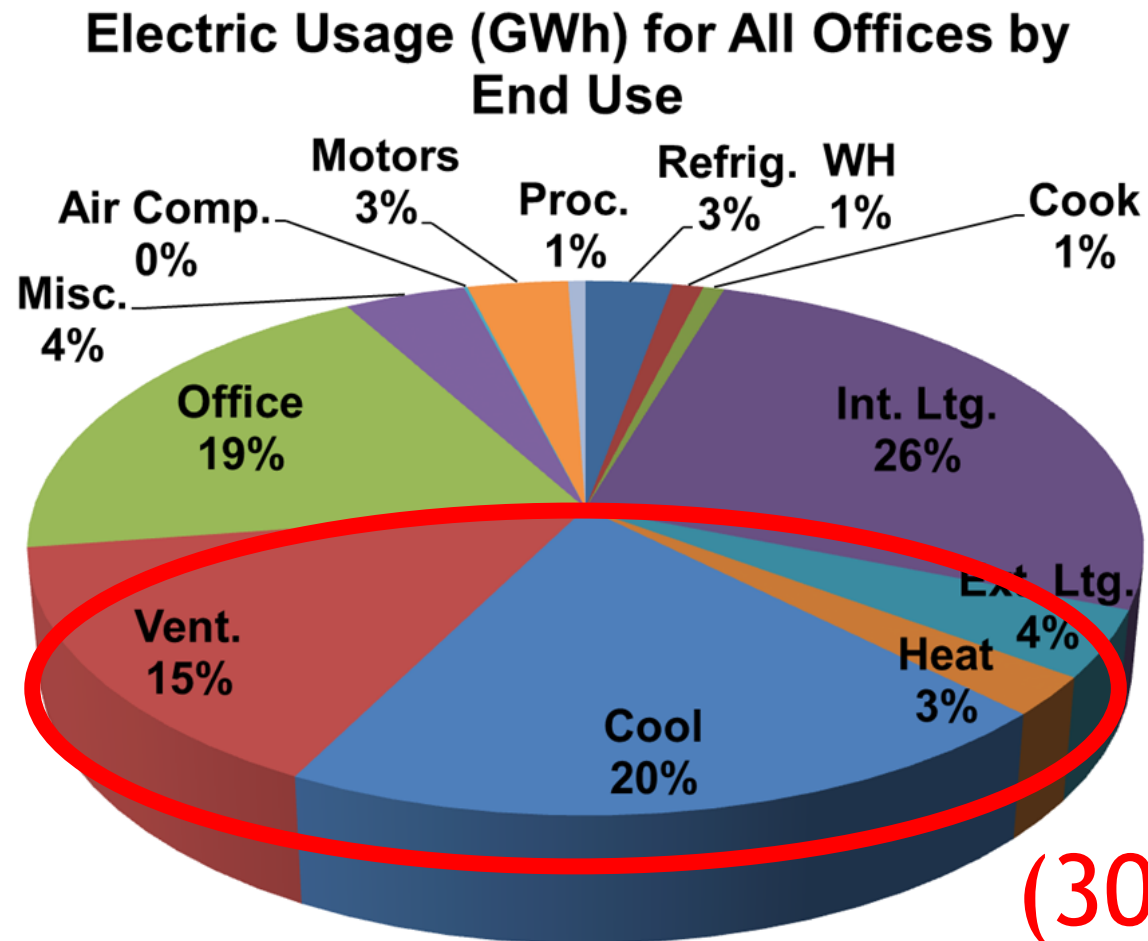

HVAC=40%

Fans=15%
(30%-40%) of HVAC



Legislation, Regulation, Rules, Standards & Codes...



Legislation, Regulation and Rules

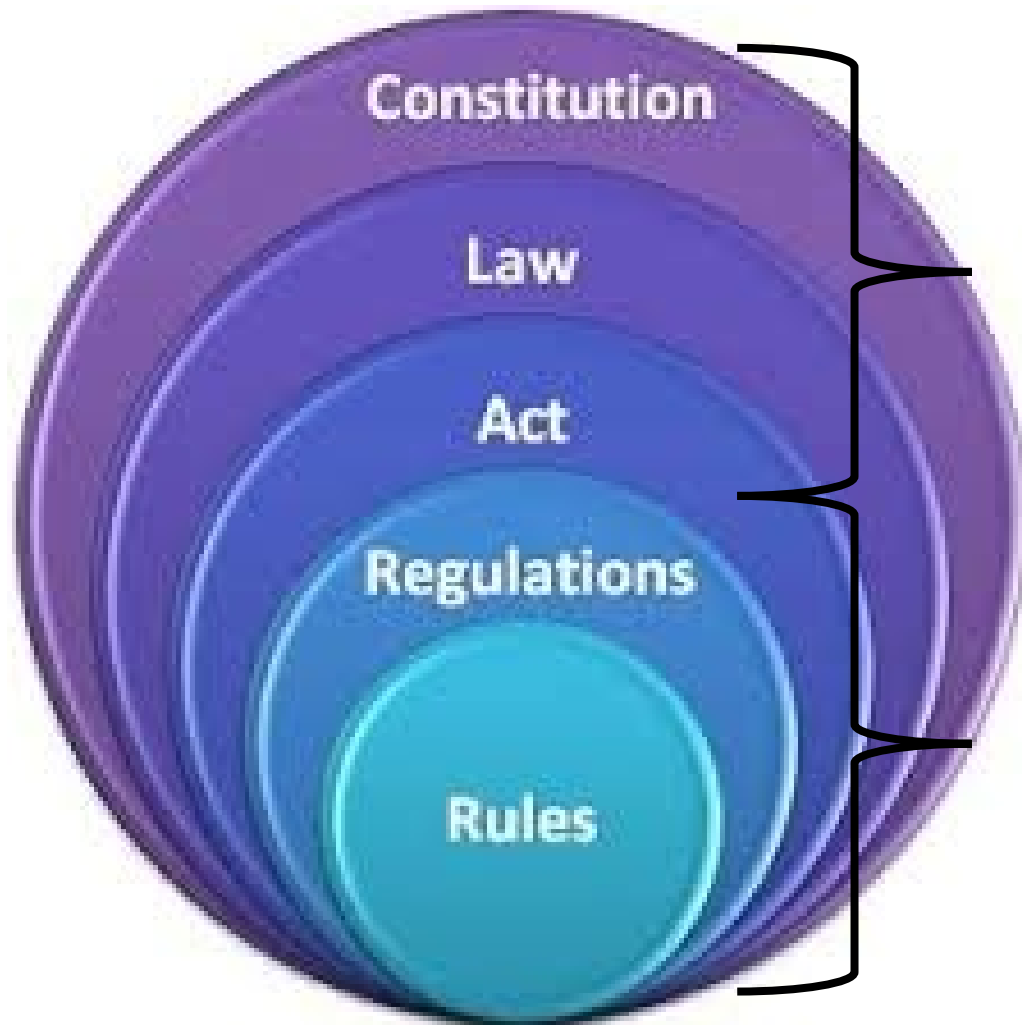

Requires Act of Congress



Drafted by
DOE, EPA,
CEC, ...



Standards and Codes

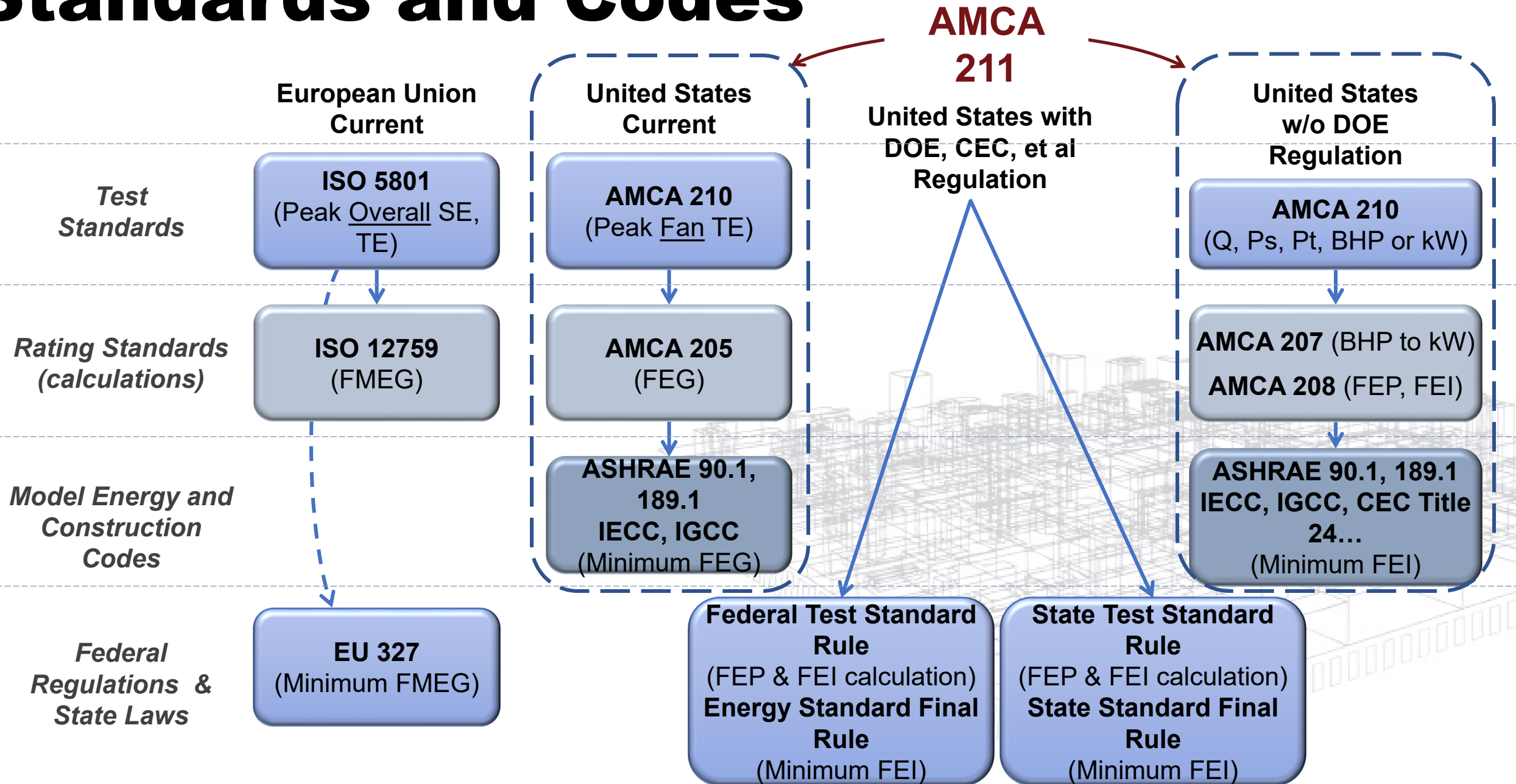

Fan Energy Consumption

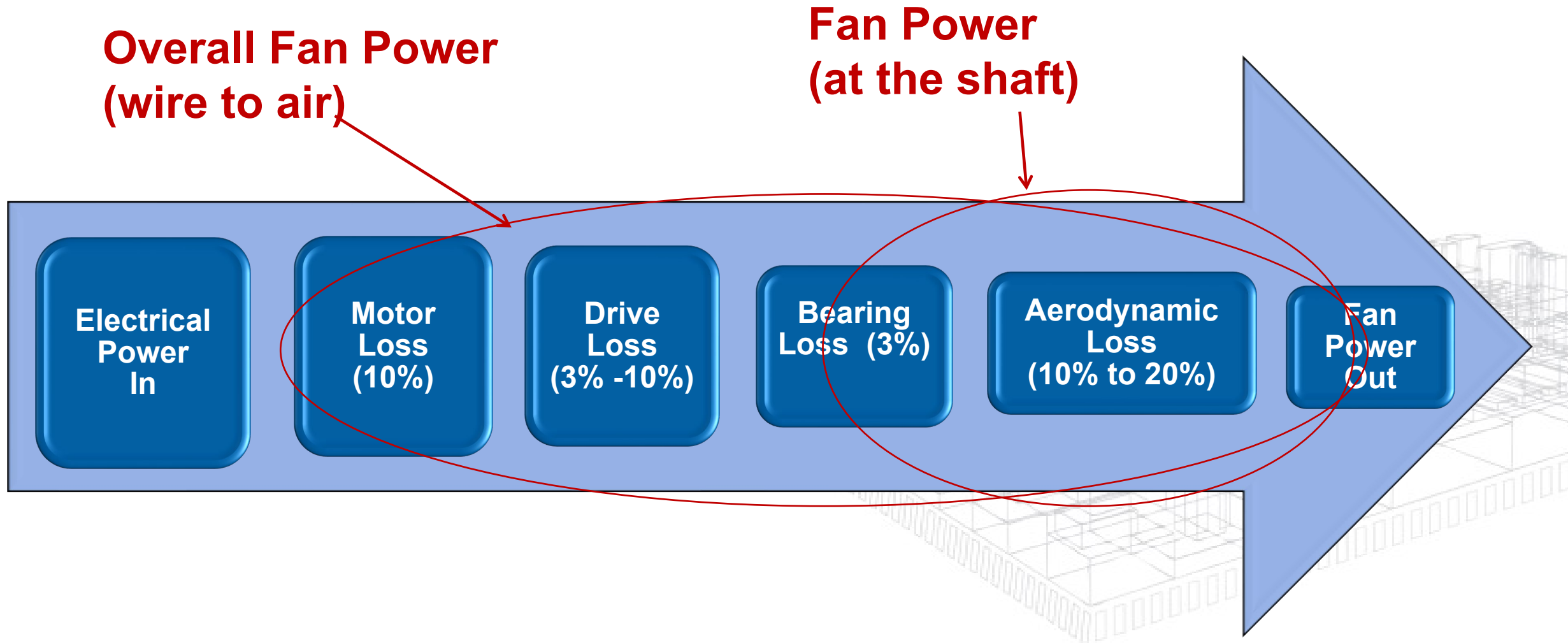

What is Fan Efficiency?

$$\text{Efficiency} = \frac{\text{Power Output}}{\text{Power Input}}$$

$$\text{Fan Efficiency} = \frac{\text{CFM} \times \text{Pressure}}{\text{BHP}}$$

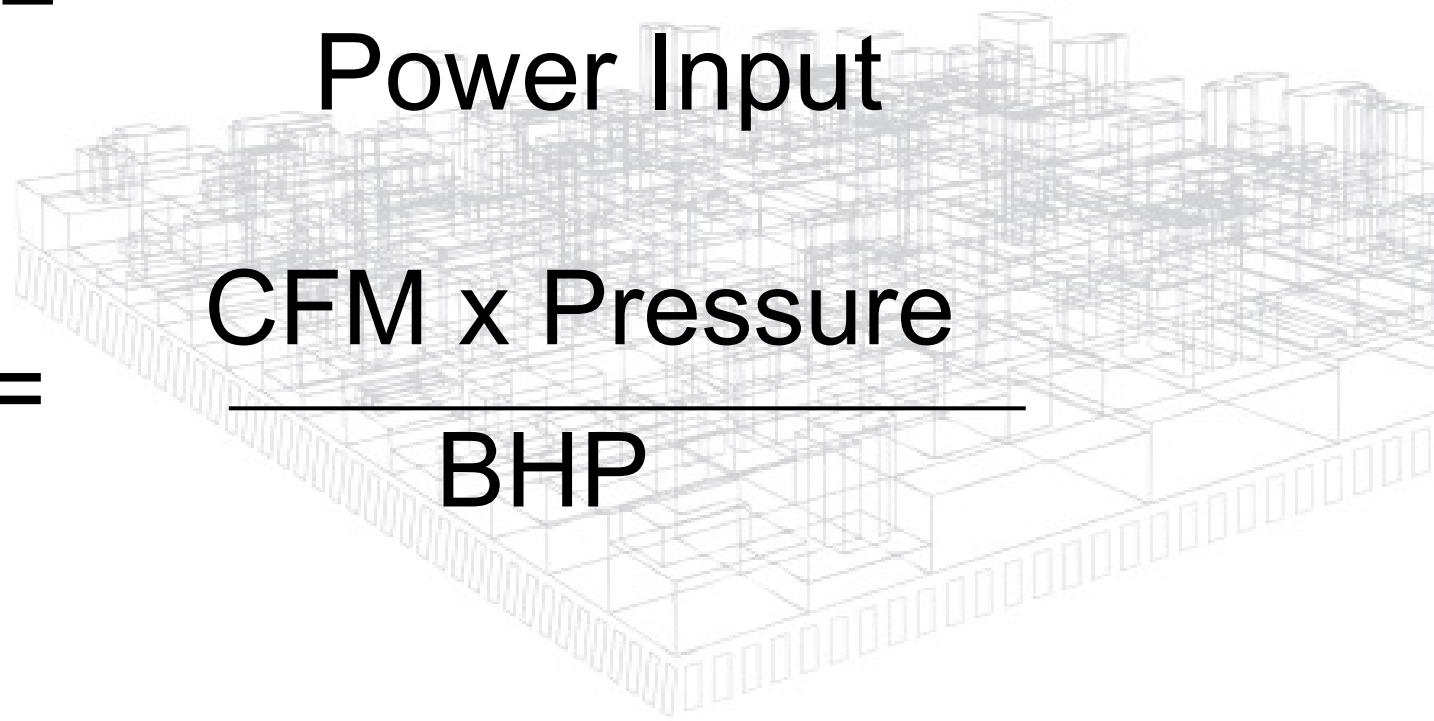

What is Fan Efficiency?

$$\text{Static Efficiency} = \frac{\text{CFM} \times P_s}{6343.3 \times \text{BHP}} \times 100\%$$

$$\text{Total Efficiency} = \frac{\text{CFM} \times P_T}{6343.3 \times \text{BHP}} \times 100\%$$

$$P_T = P_s + P_v$$

Shaft to Air

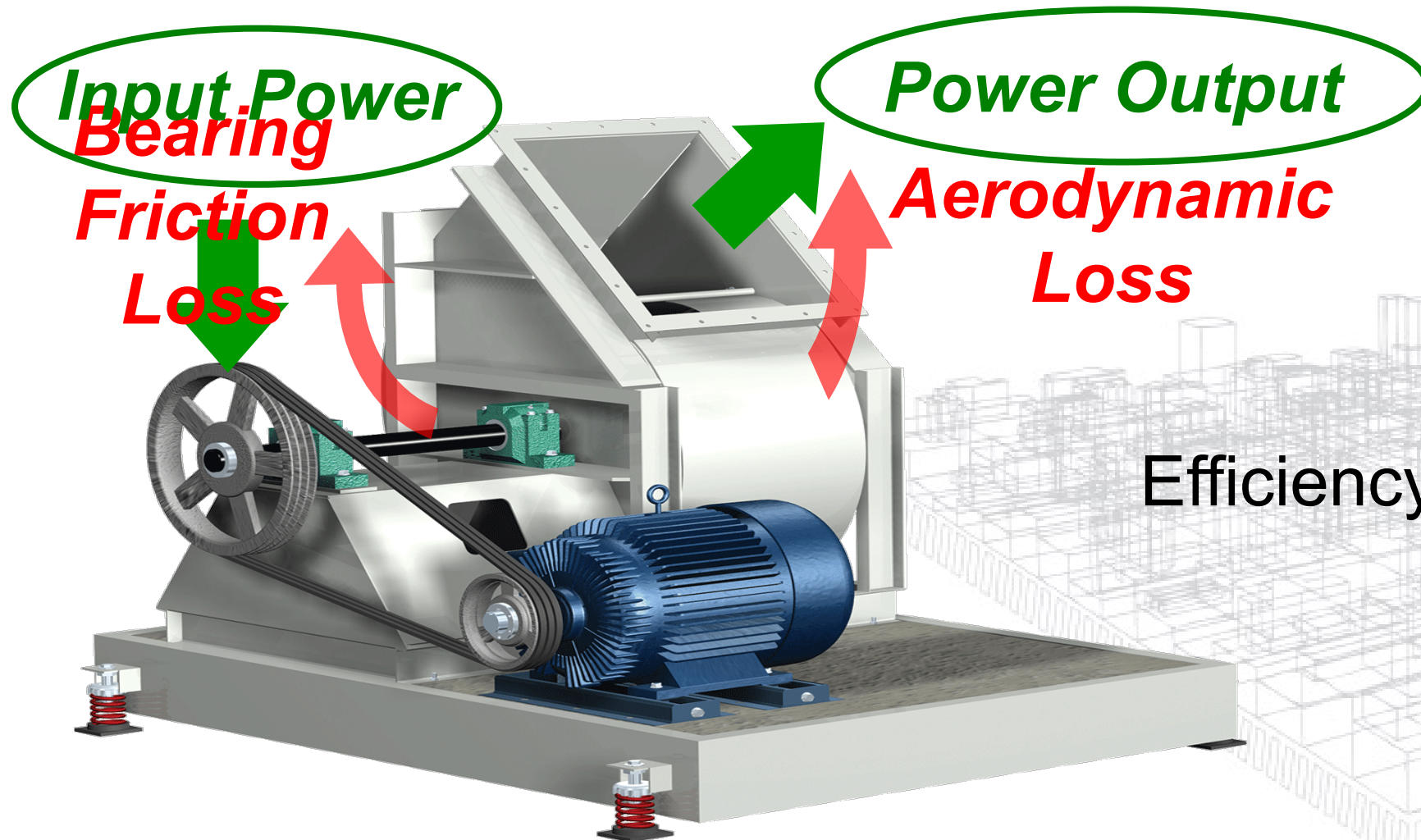

$$\text{Efficiency} = \frac{\text{Power Output}}{\text{Power Input}}$$

Wire to Air

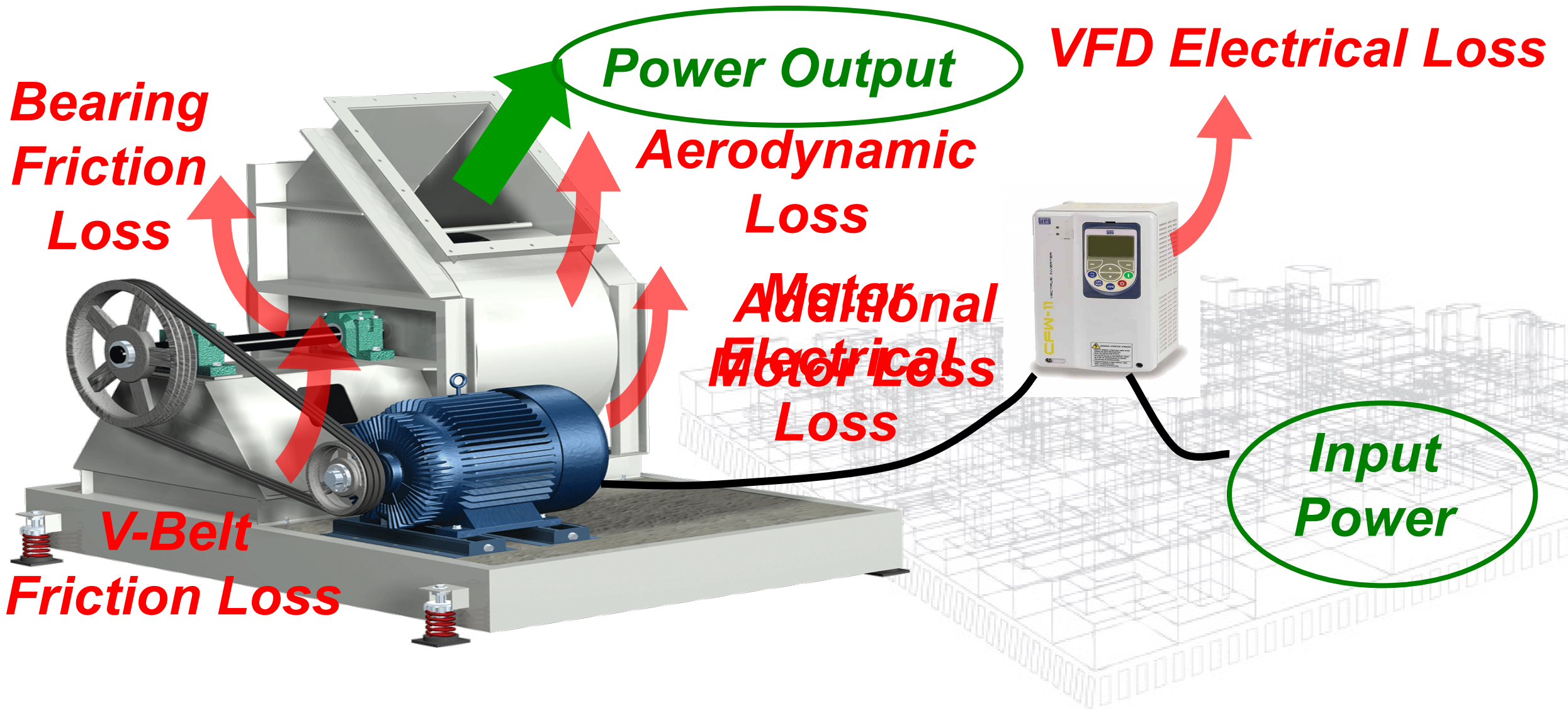

Fan Curves

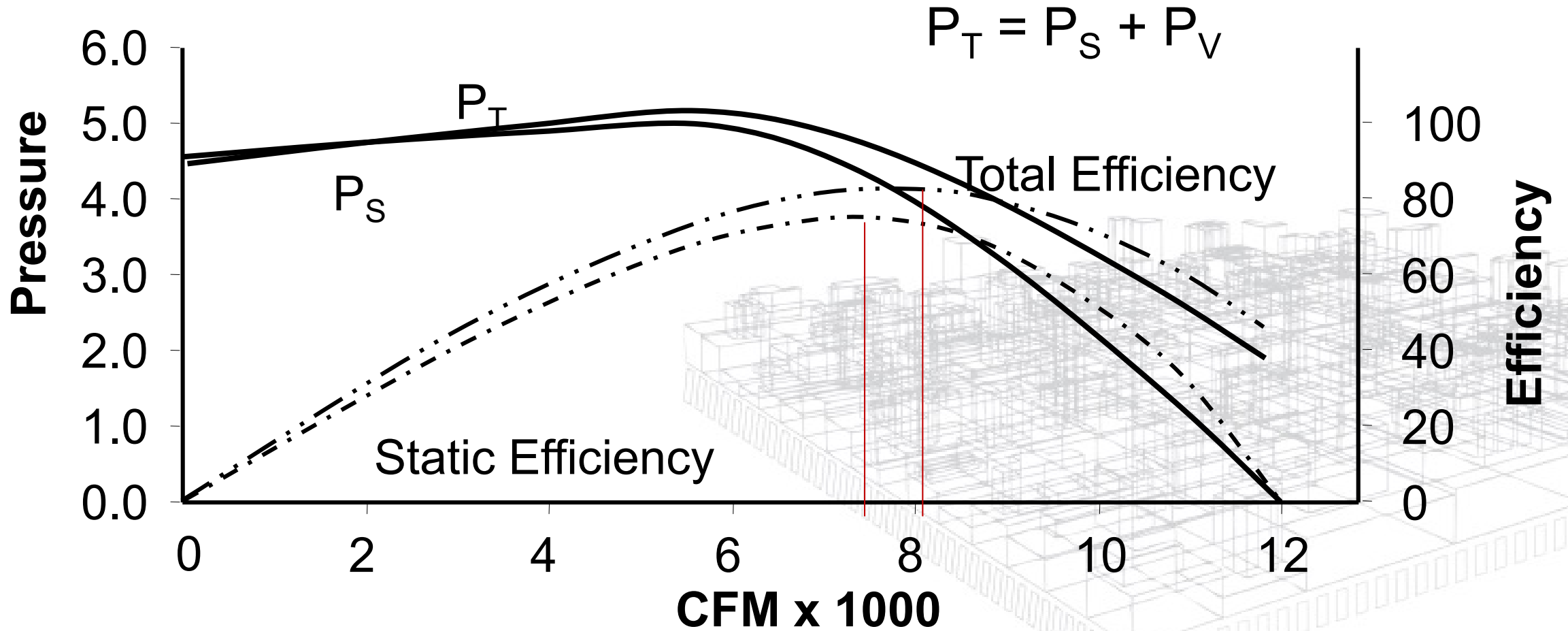

Fan Selection for Efficiency

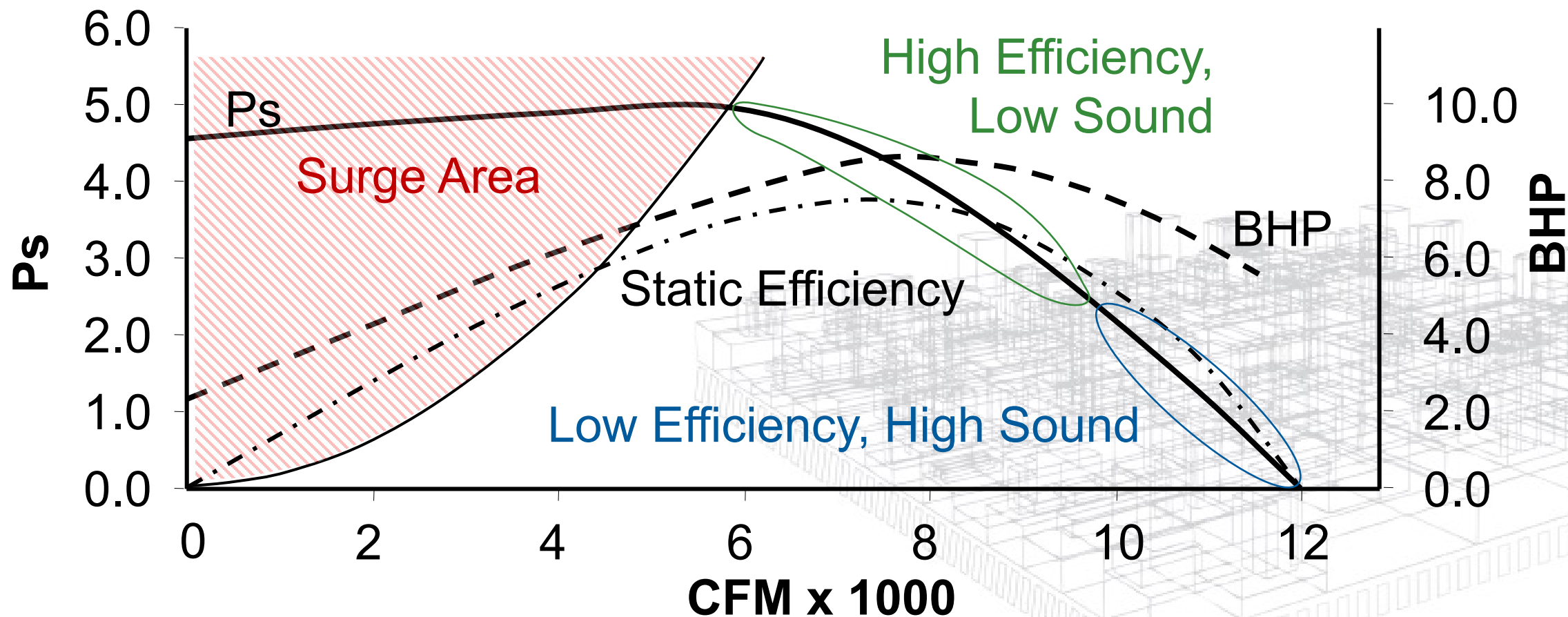

Fan Performance vs. Fan Application

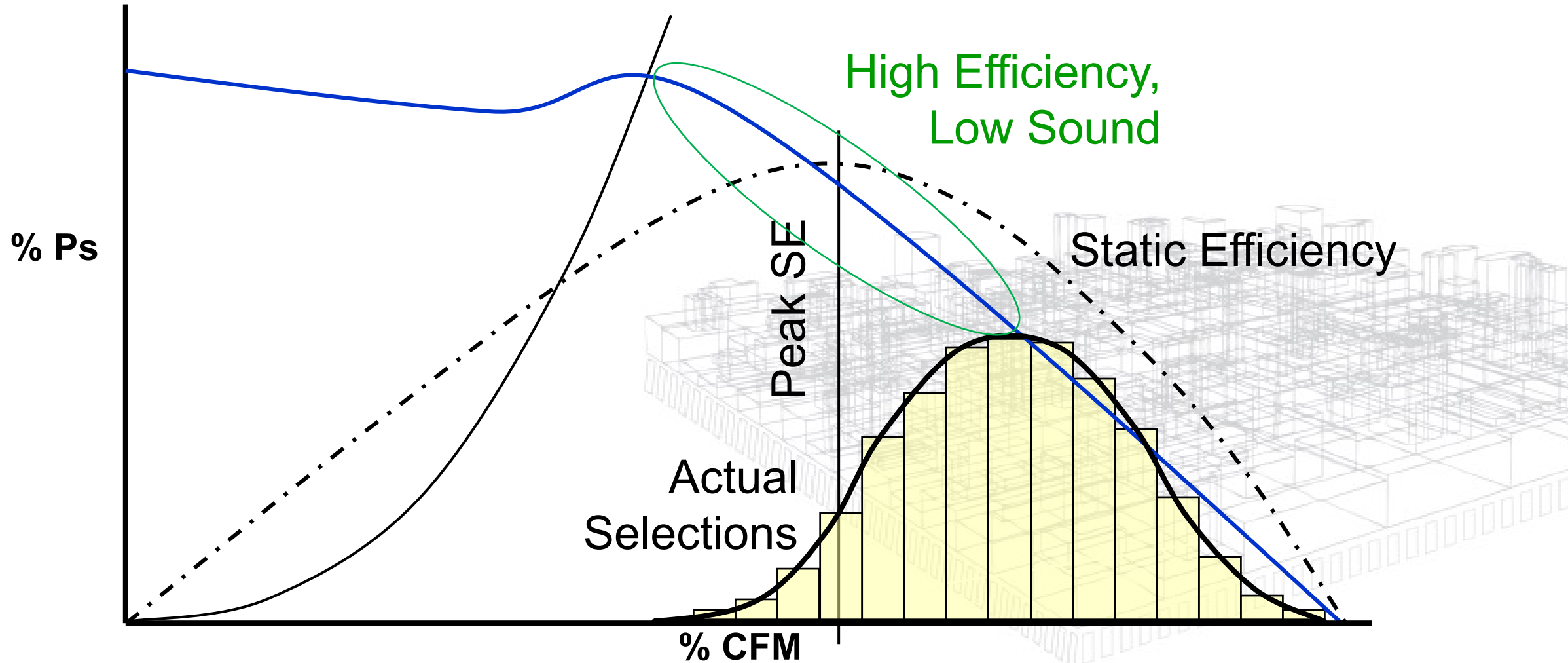

Why do Customers Select Inefficient Fans?

1. Bidding Process; Need to be low on Bid Day.

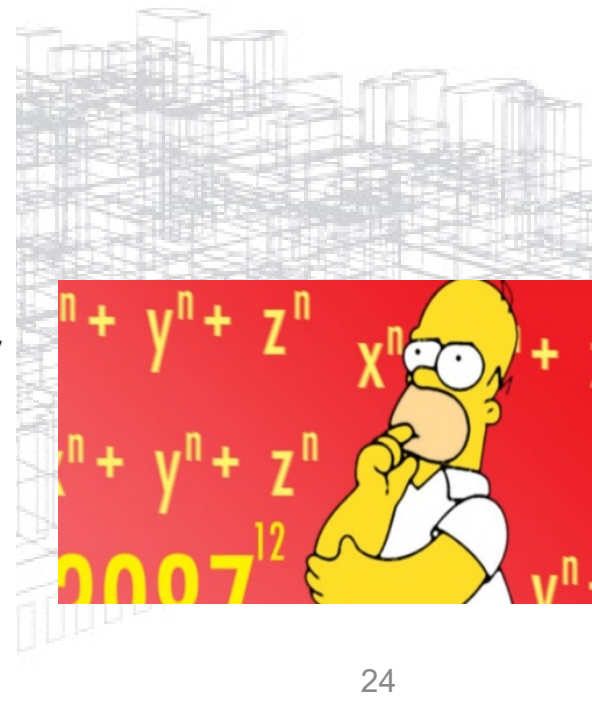
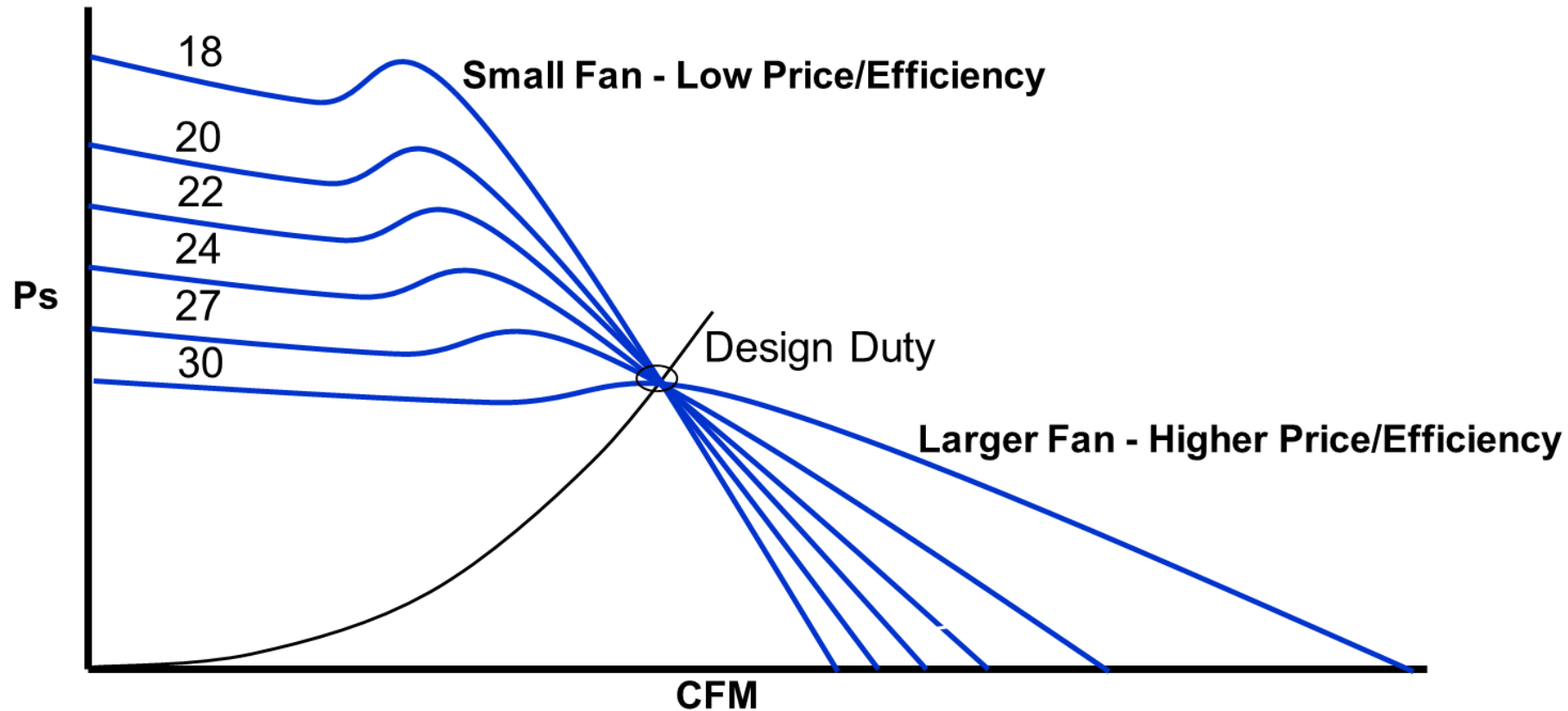

Why do Customers Select Inefficient Fans?

1. Bidding Process; Need to be low on Bid Day.

2. Safety Factor – Avoid Stall/Surge
 - A. Inaccurate Fan System Pressure Loss Calcs.
 - B. Safety Factor for System Effect.

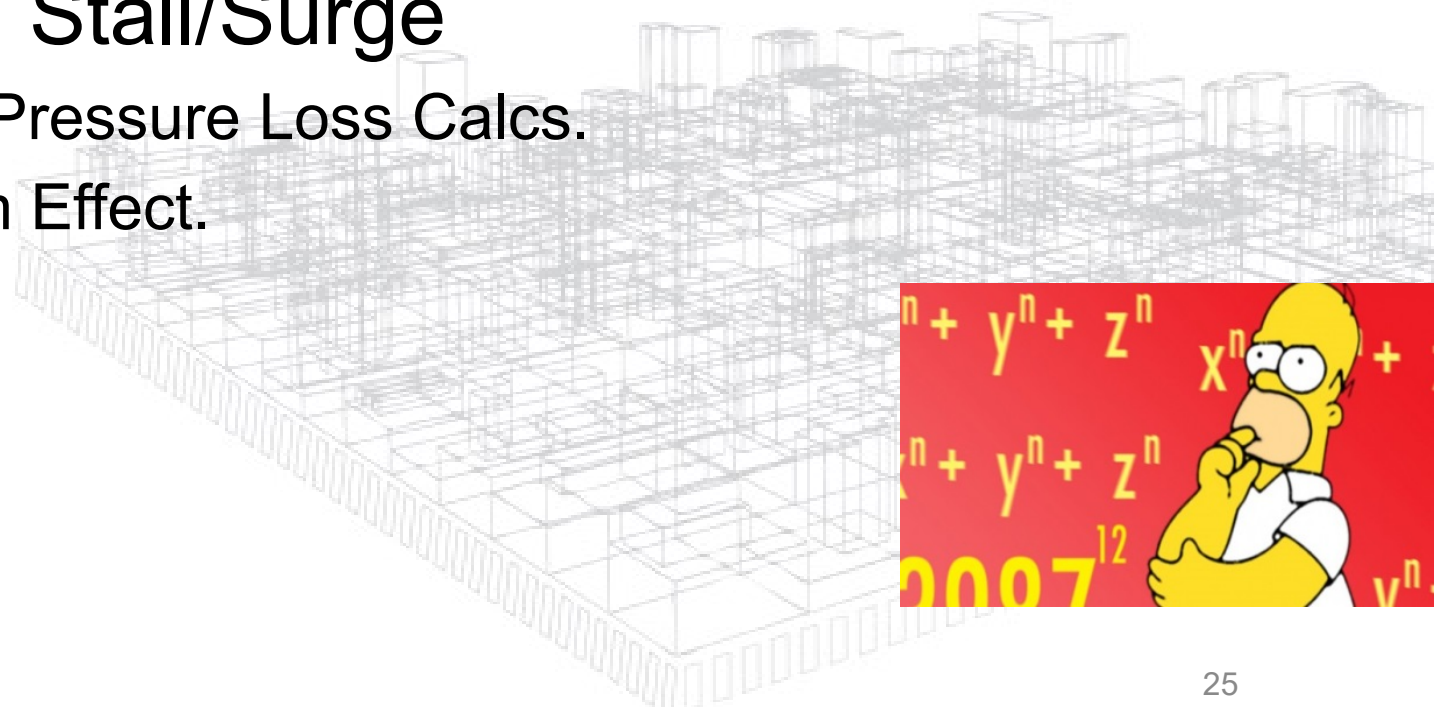



Fan Energy Regulations & Metrics...

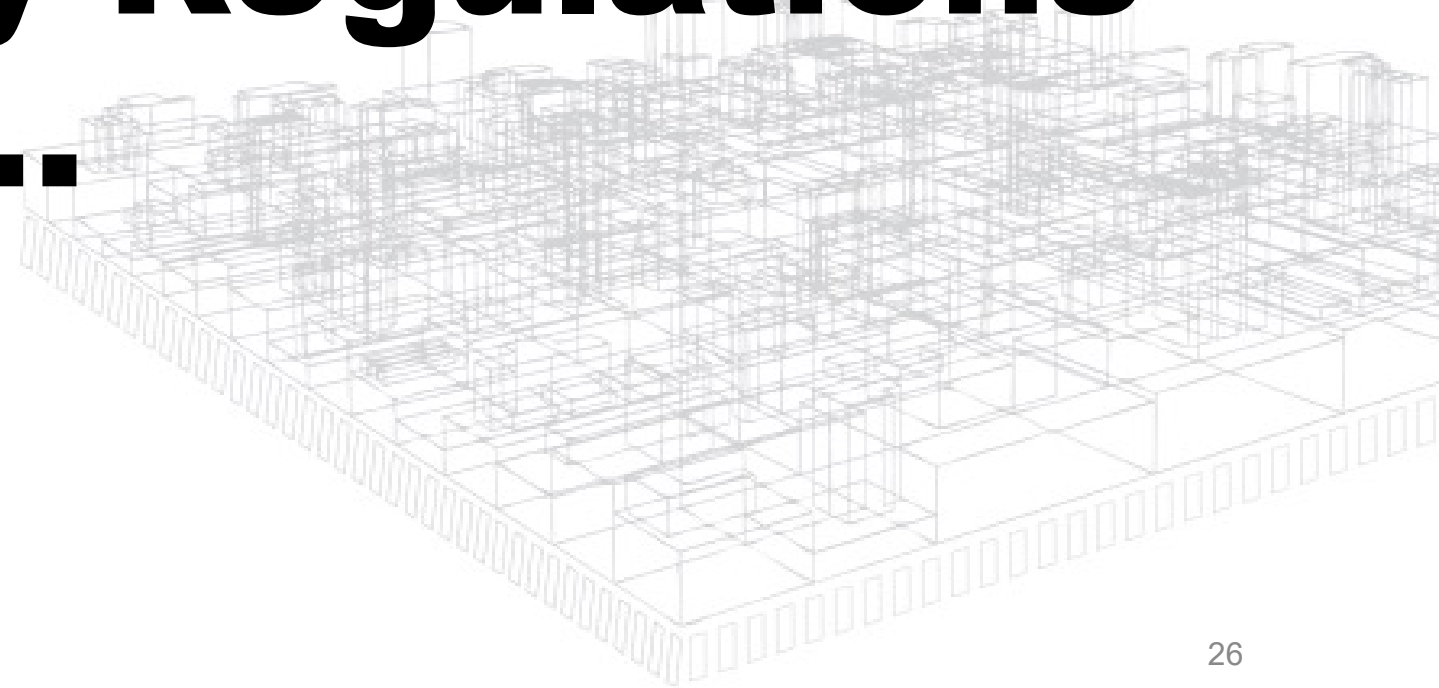

What Defines Good Fan Energy Regulation?



1. Saves Energy
2. Applies to all fans
 - A. Promotes Proper Selection
 - B. Encourage Substitution



3. Prevents Loopholes



Fan Energy Regulation Metrics

1. Fan *Efficiency* Grade (FEG)

- Being adopted in Standards/Codes



2. Fan *Energy* Index (FEI)

- DOE Regulation (in holding pattern)
- AMCA is developing a Certified Ratings Program
- CEC Regulation – Likely to pick up on DOE work



Shaft to Air

Input Power

Power Output

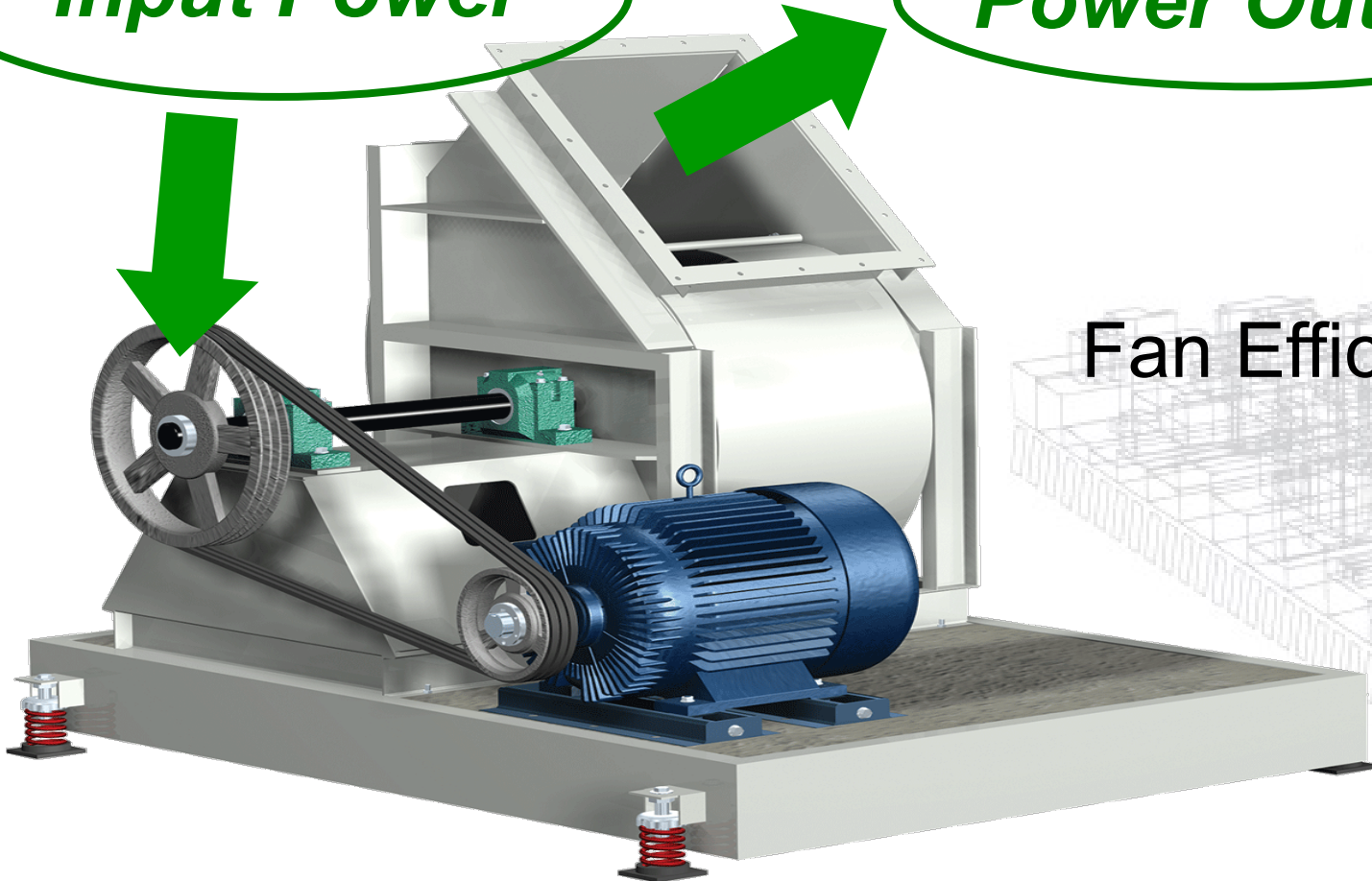

Fan Efficiency =

$$\frac{\text{CFM} \times \text{Pressure}}{\text{BHP}}$$

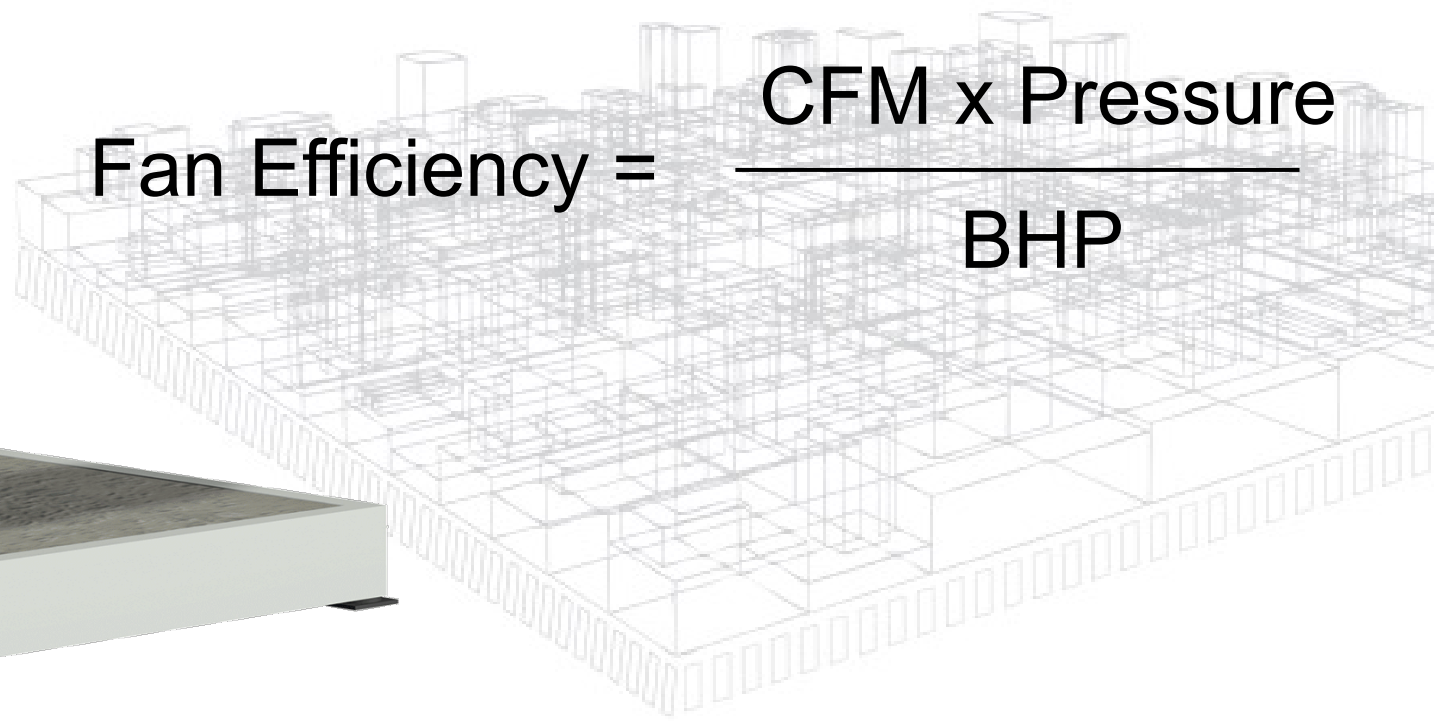

Fan Efficiency Grades AMCA 205

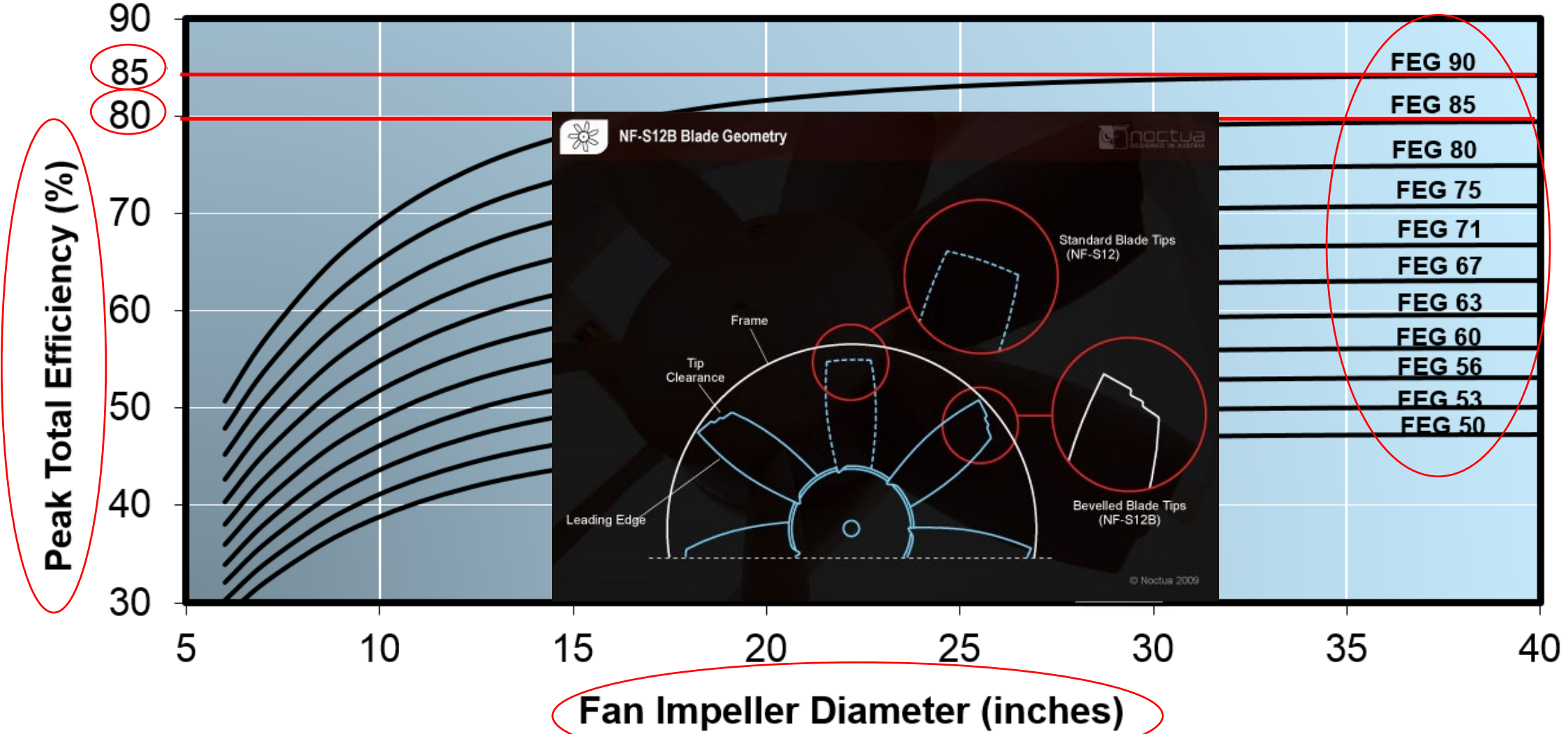

Fan Efficiency Grades AMCA 205

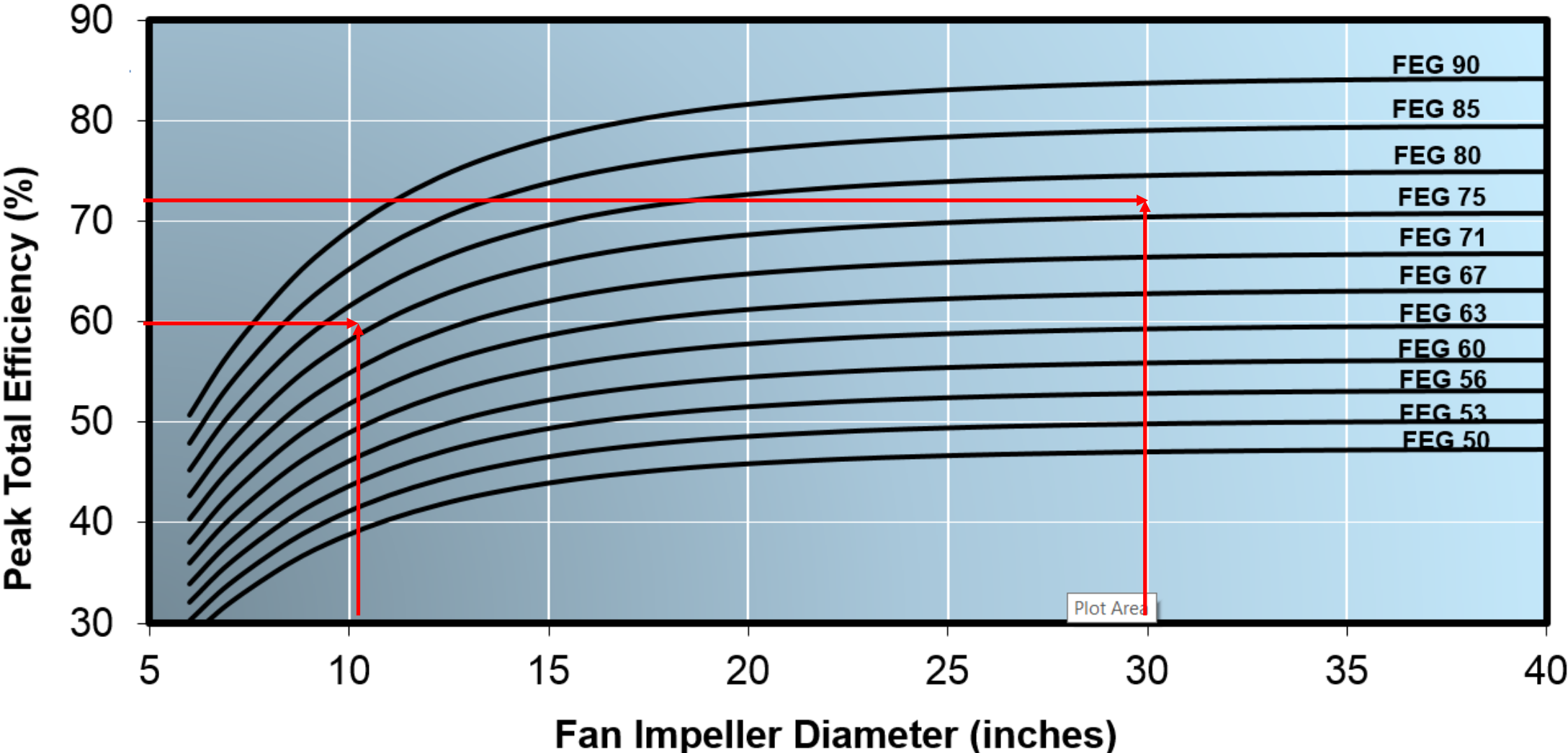

Fan Performance vs. Fan Application

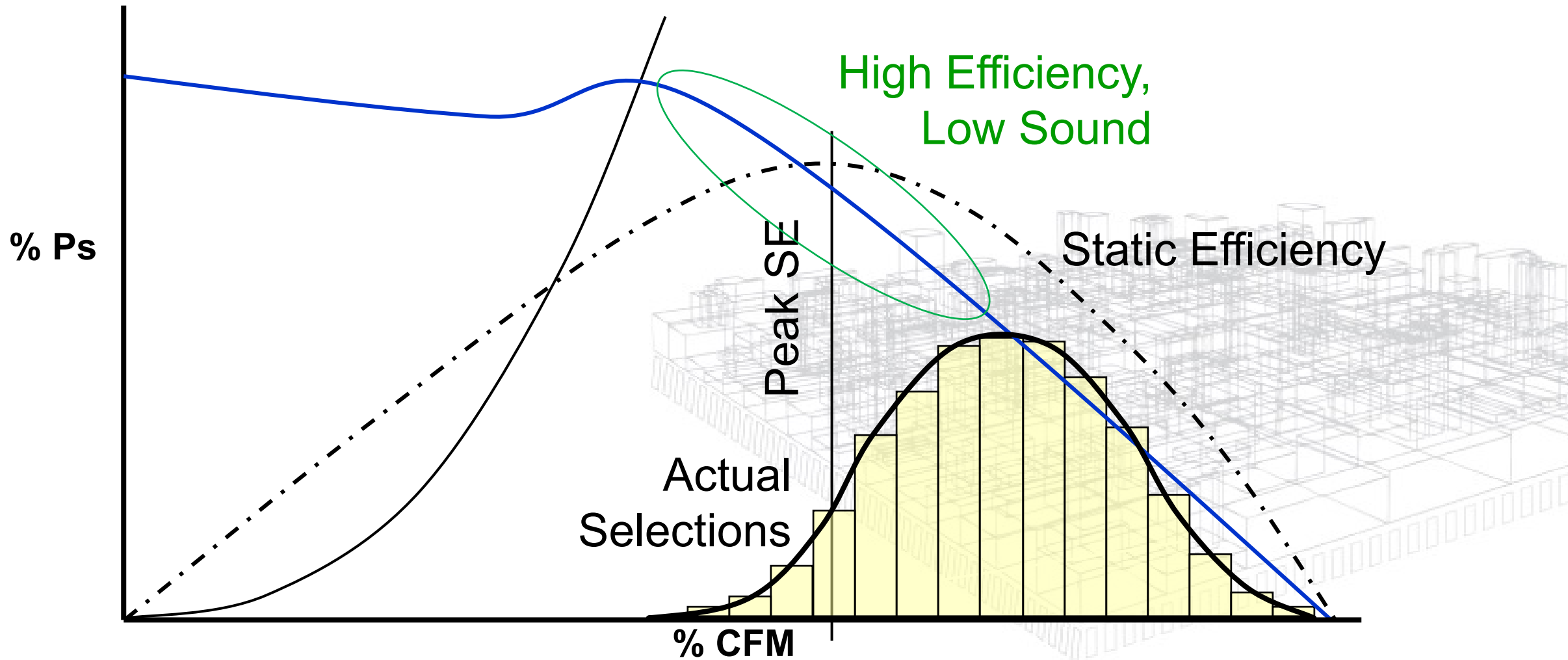

Impact of ASHRAE 90.1 - 2013 2012 Fan Sales

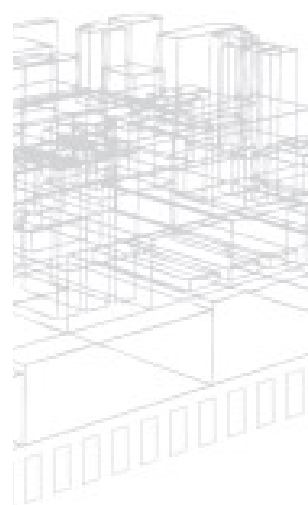
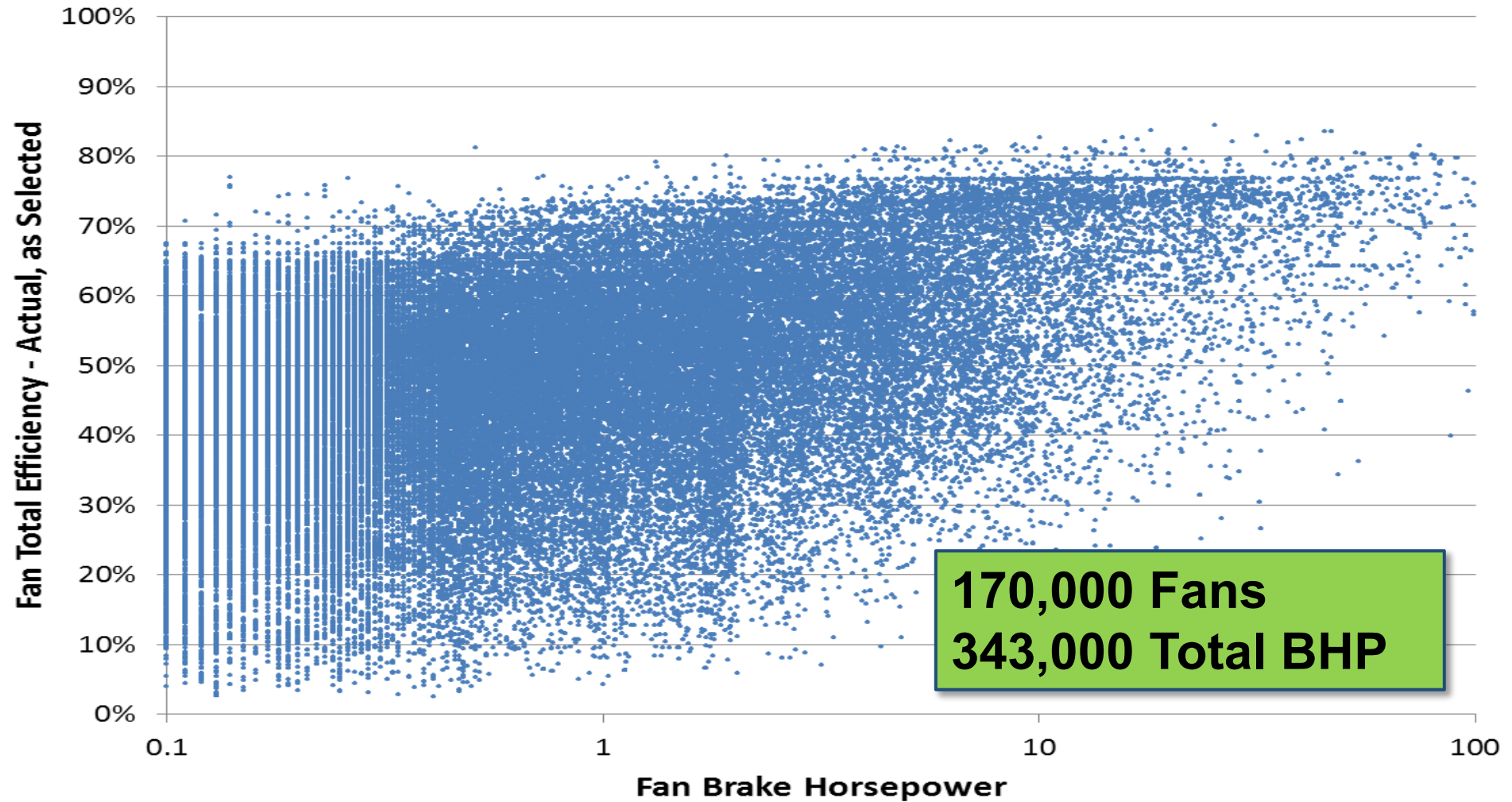

FEGs in Codes

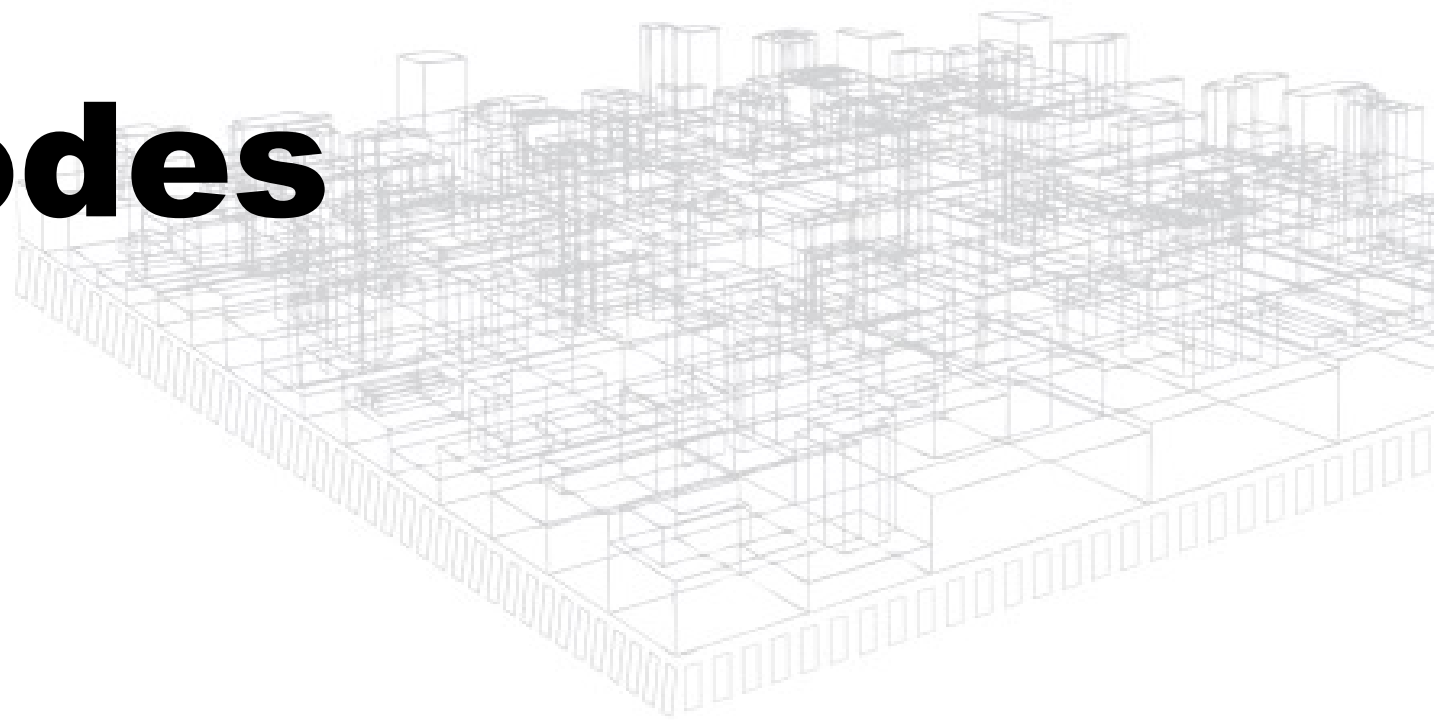

ASHRAE 90.1 - 2013

6.5.3.1 Fan System Power and Efficiency Limitation

6.5.3.1.3 Fan Efficiency. Fans shall have a *Fan Efficiency Grade* (FEG) of 67 or higher based on manufacturers' certified data, as defined by AMCA 205.

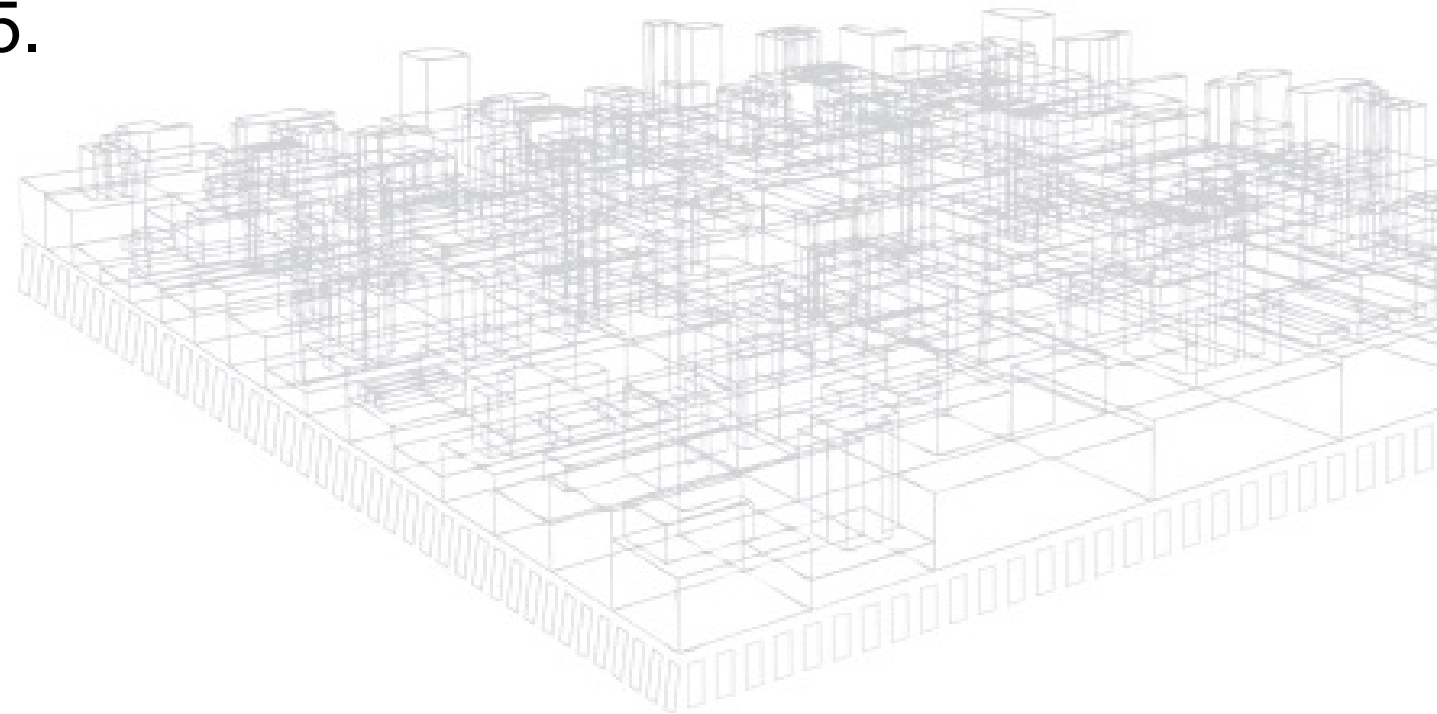

Fan Types

40,000 CFM at 0.25" Ps

Model	Impeller Dia	BHP	FEG	\$ Cost
Sidewall Prop	54"	7.11	56	1.0
Tube Axial	54"	8.30	67	1.7
Vane Axial	54"	6.87	75	4.4
Housed Centrifugal	49"	13.4	90	3.8
Housed Centrifugal	60"	6.8	90	6.1

Fan Types

Codes relying on minimum Fan Efficiency Grades will result in replacing this:

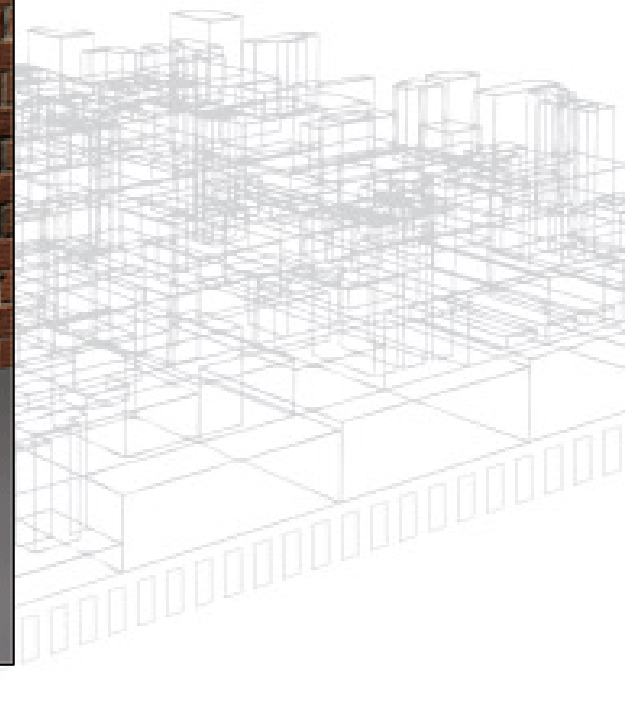
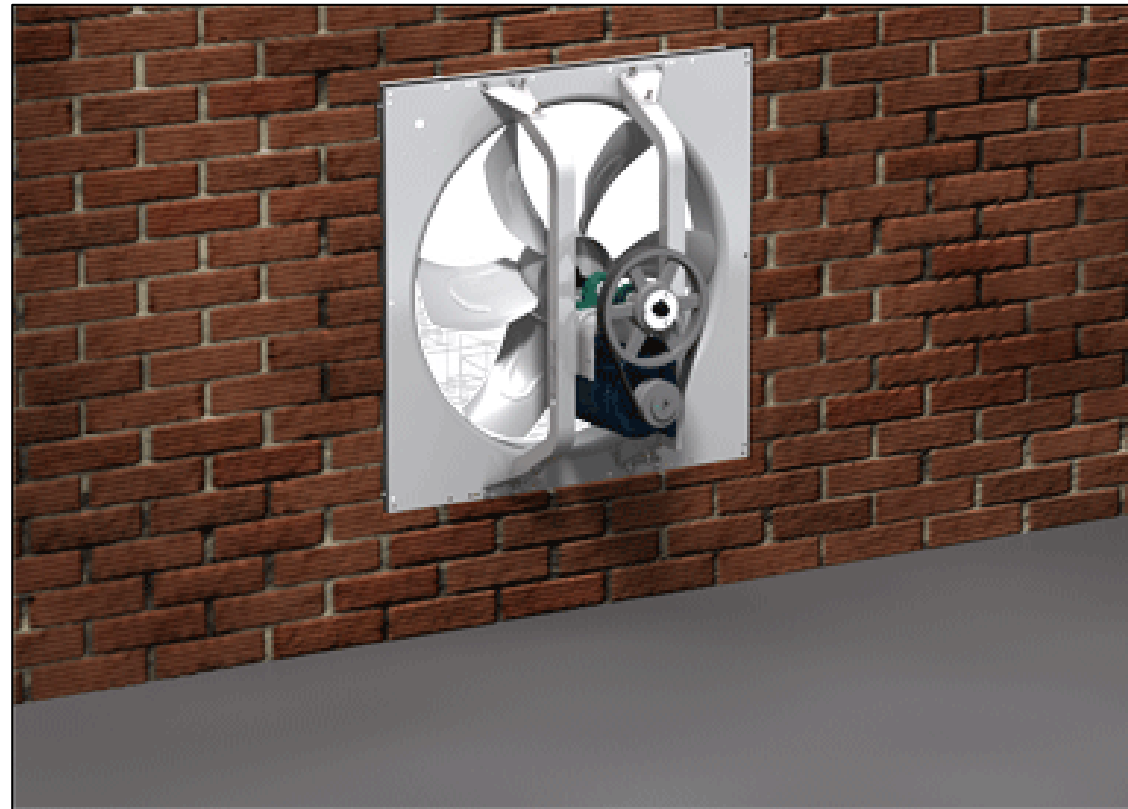

Fan Types

With this:

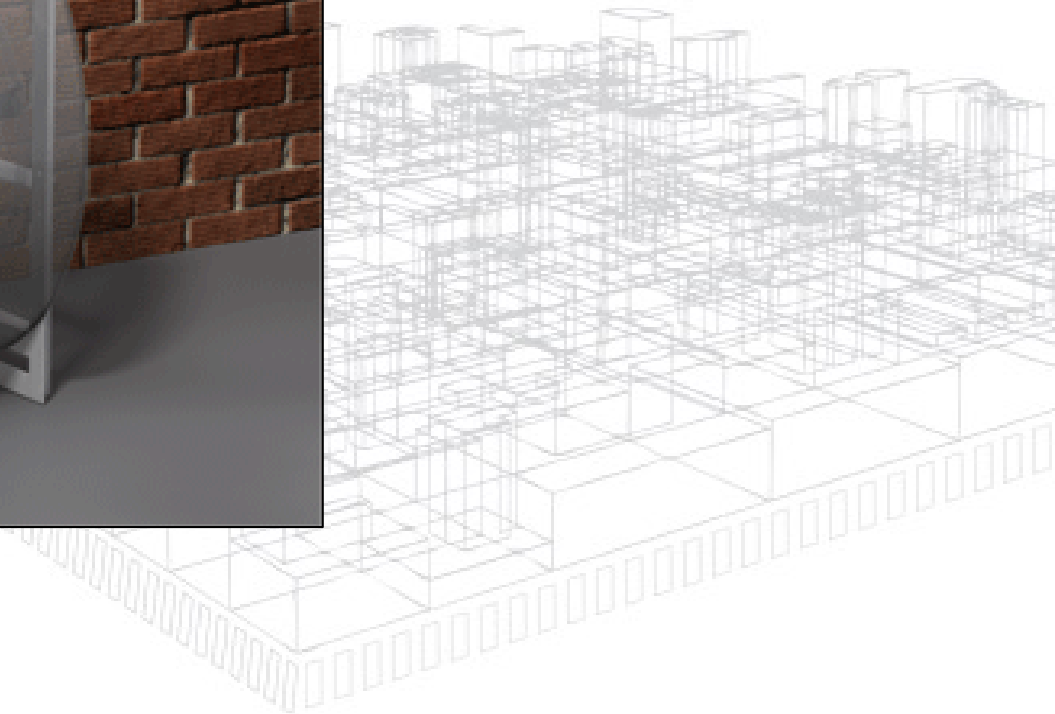
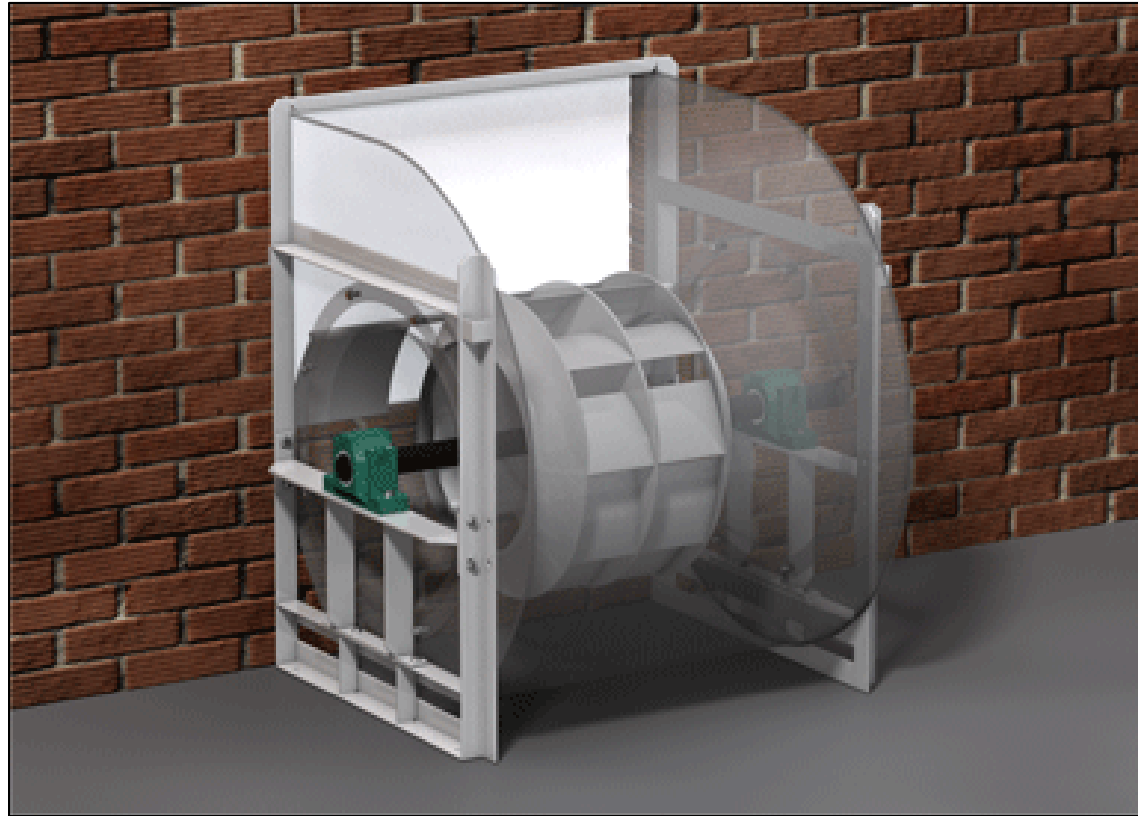

Fan Selections

15,000 CFM at 4" Ps

SW Airfoil Centrifugal	Fan Class	Oper BHP	Static Eff	Total Eff	Peak Static Eff	Peak Total Eff	FEG
22	III	24.5	38%	55%	75%	79%	85
24	III	19.0	50%	64%	74%	79%	85
27	II	16.2	58%	70%	74%	79%	85
30	II	13.6	70%	79%	78%	83%	85
33	I	12.5	75%	82%	78%	83%	85
36	I	12.0	78%	83%	78%	83%	85

ASHRAE 90.1 - 2013

- **6.5.3.1 Fan System Power and Efficiency Limitation**
- **6.5.3.1.3 Fan Efficiency**

Fans shall have a **Fan Efficiency Grade (FEG)** of 67 or higher based on manufacturers' certified data, as defined by AMCA 205. The total efficiency of the fan at **the design point of operation shall be within 15 percentage points of the maximum total efficiency of the fan.**

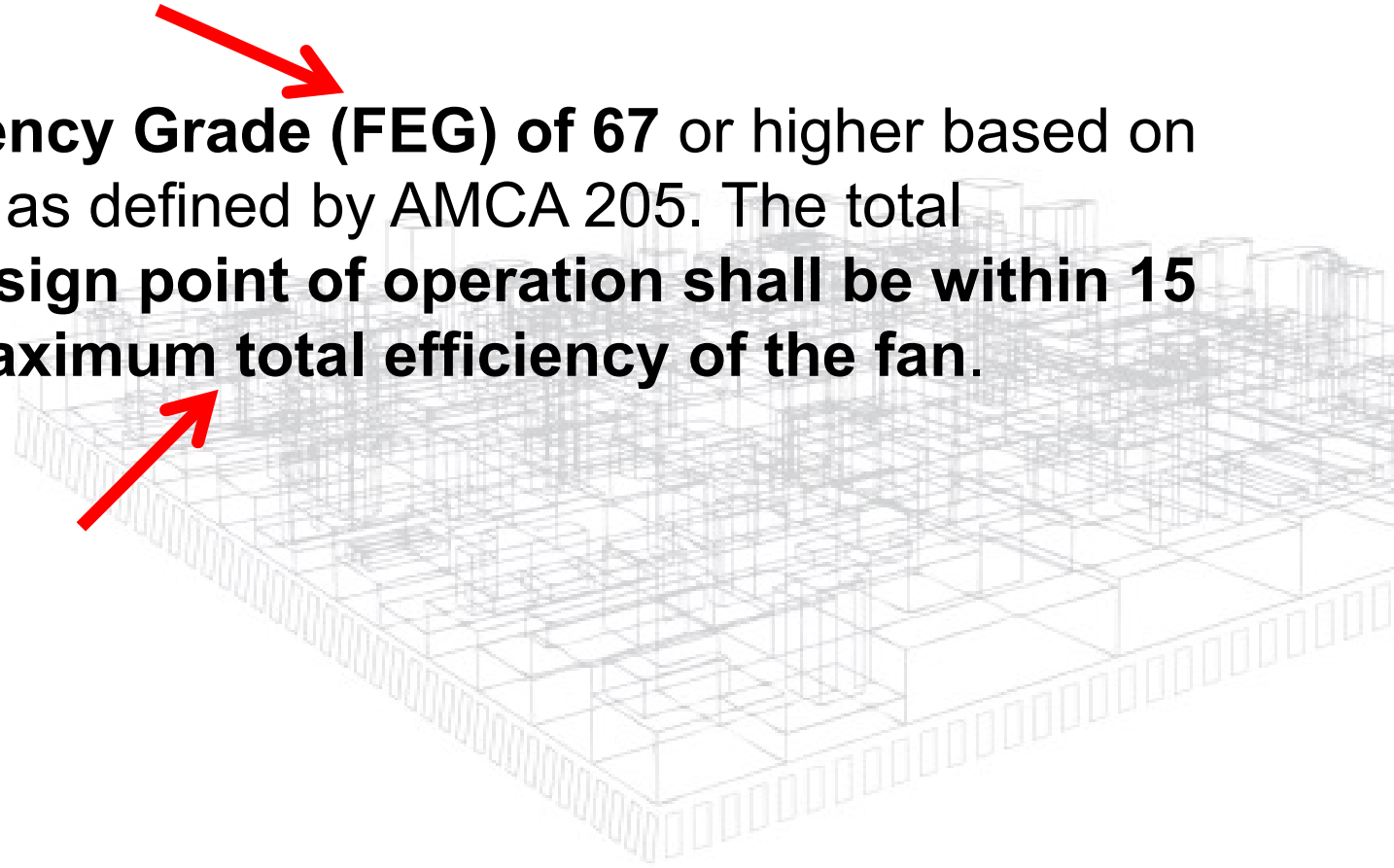

Fan Efficiency Grade

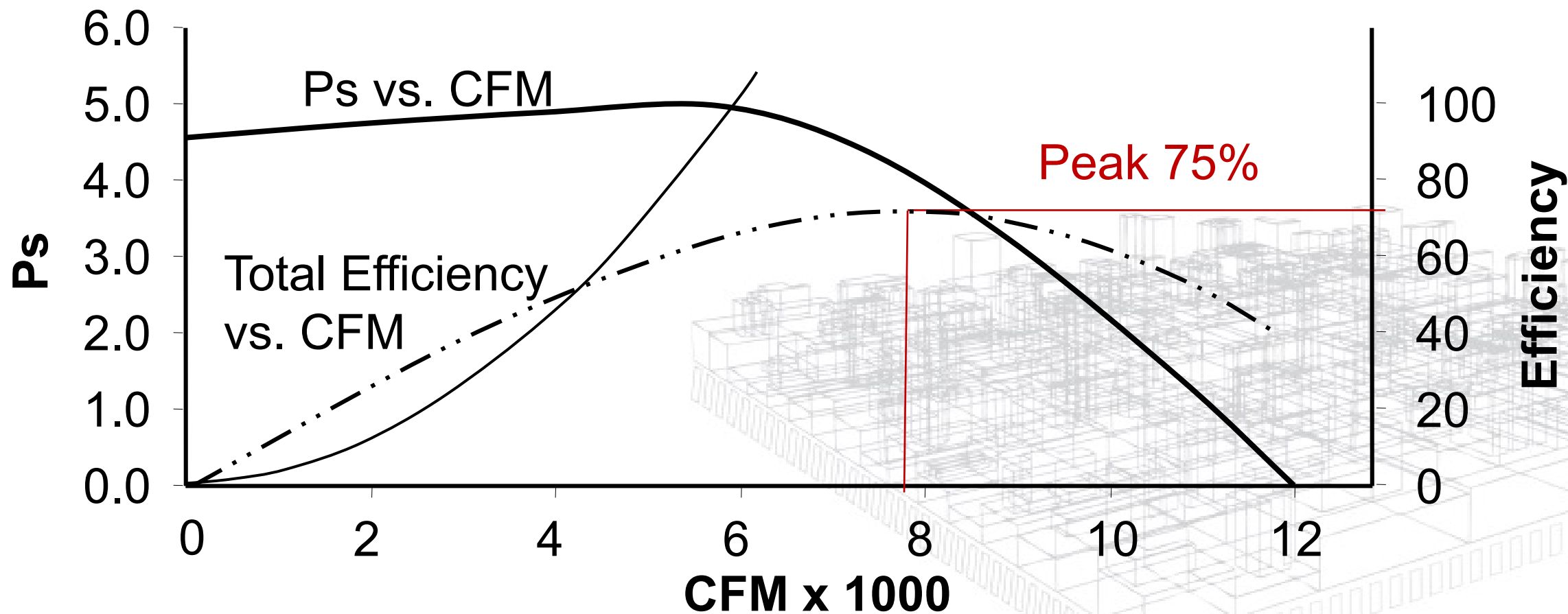

Fan Efficiency Grades

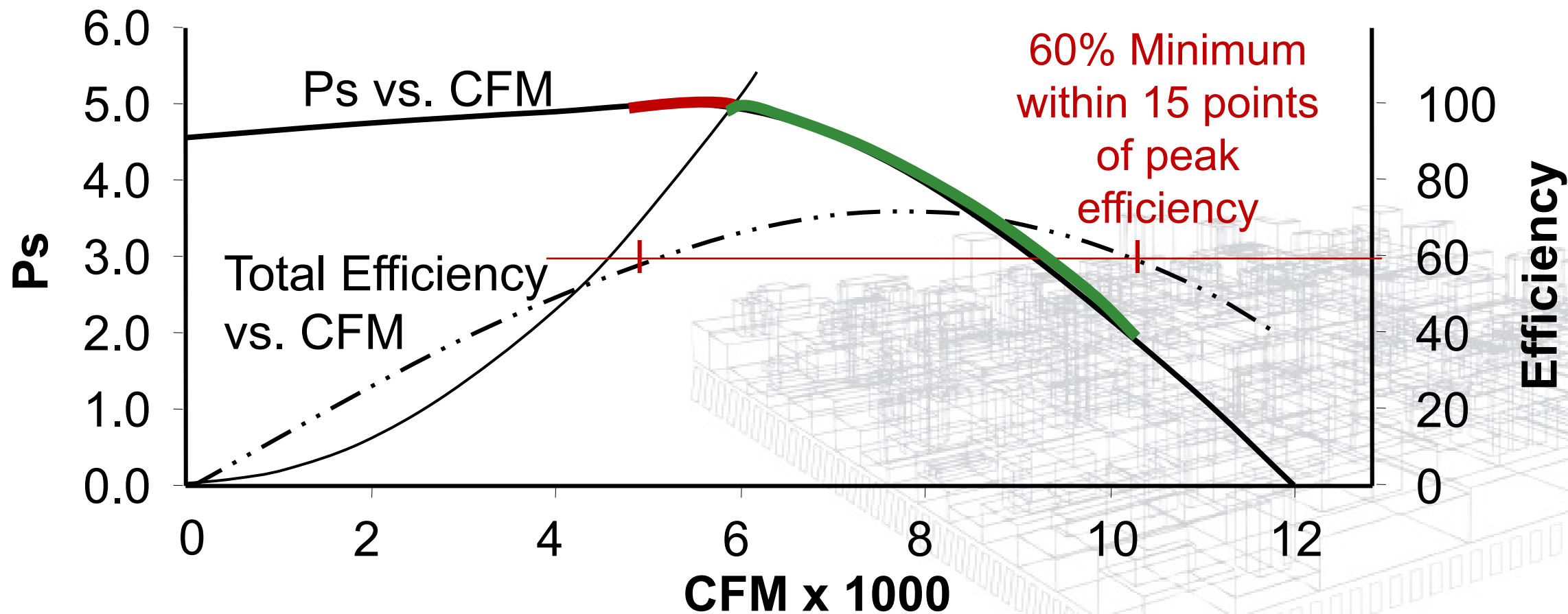

ASHRAE 90.1 - 2013

- 6.5.3.1 Fan System Power and Efficiency Limitation
- **6.5.3.1.3 Fan Efficiency.** Fans shall have a Fan Efficiency Grade (**FEG**) of **67 or higher** based on manufacturers' certified data, as defined by AMCA 205. The total efficiency of **the fan at the design point of operation shall be within 15 percentage points of the maximum total efficiency of the fan.**

Exceptions:

- Individual fans with a motor nameplate of 5 hp or less that are not part of a group operated as the functional equivalent of a single fan.**
- Multiple fans in series or parallel (e.g. fan arrays) series that have a combined motor power of 5 hp or less and are operated as the functional equivalent of a single fan.
- Fans that are part of equipment listed under 6.4.1.1.
- Fans included in equipment bearing a third-party-certified seal for air or energy performance of the equipment package.
- Powered wall/roof ventilators (PRV).**
- Fans outside the scope of AMCA 205
- Fans that are intend to only operate during emergency conditions

Impact of ASHRAE 90.1 - 2013 2012 Fan Sales

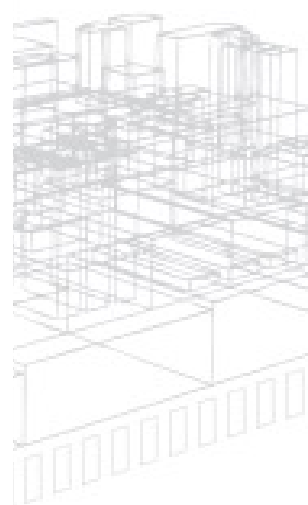
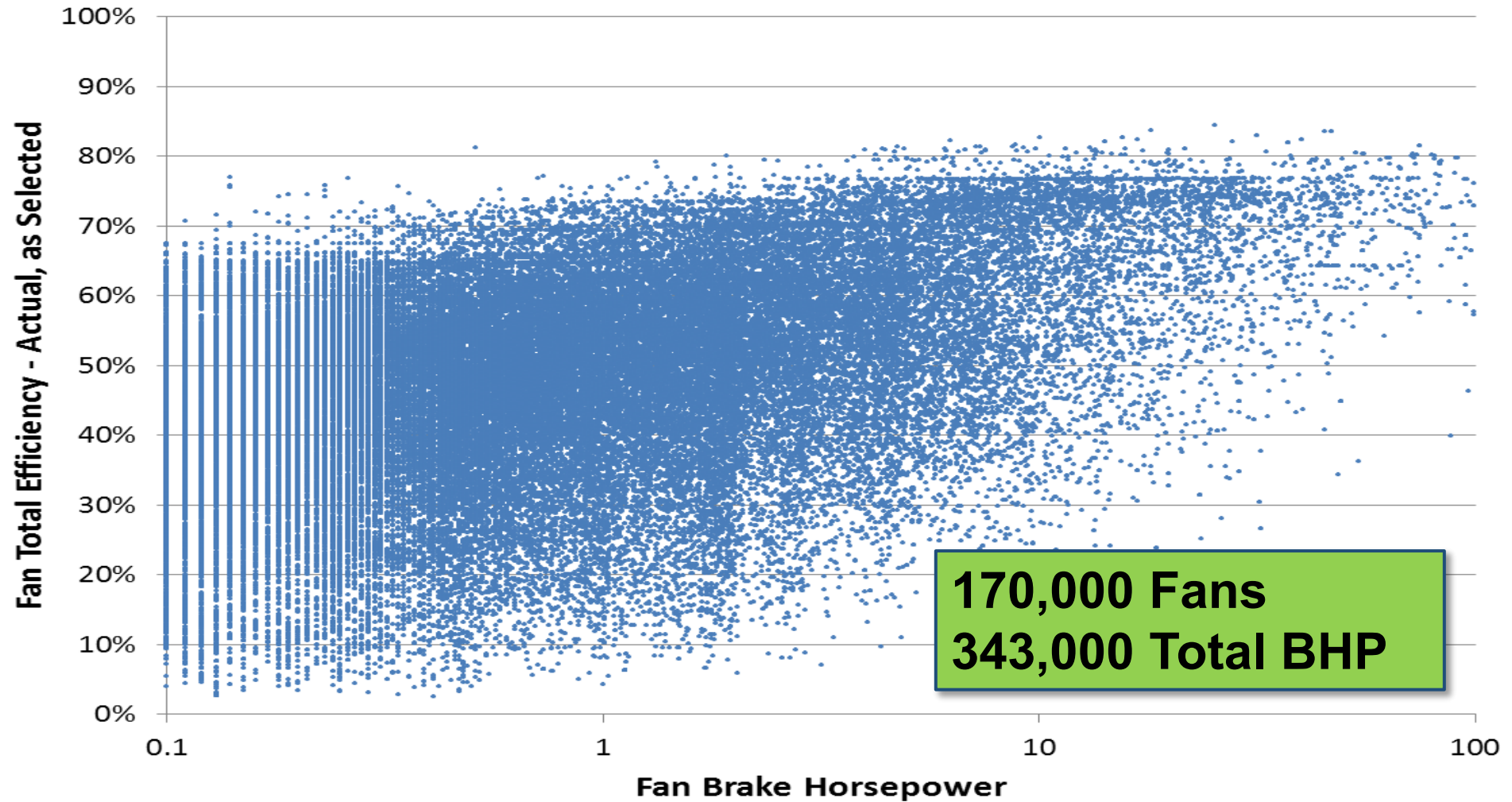

Impact of ASHRAE 90.1 - 2013 2012 Fan Sales

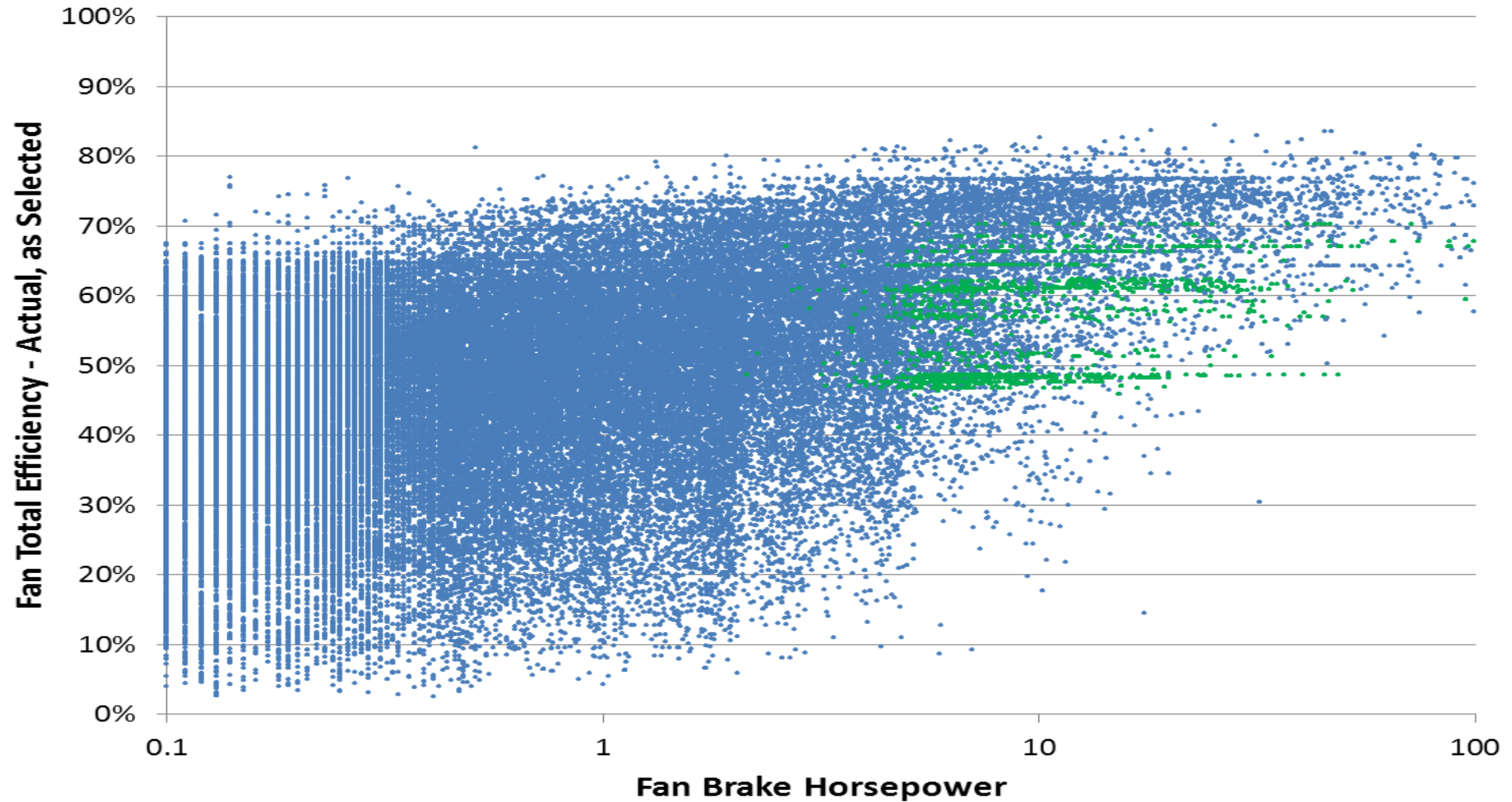

Is FEG a Good Fan Energy Regulation?



1. Saves Energy



2. Applies to all fans

A. Promote Proper Selection

B. Encourage Substitution



3. Prevents Loopholes

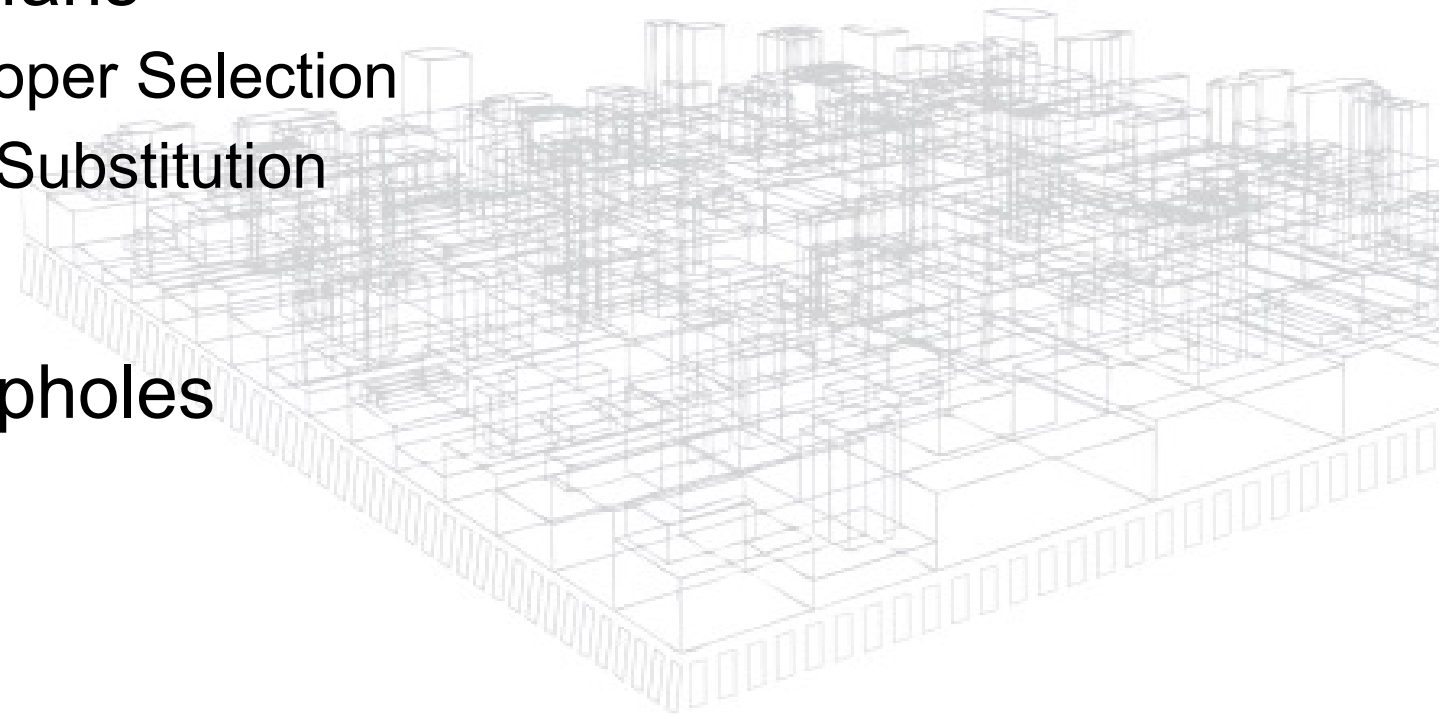

Fan Energy Regulation Metrics

- Fan Efficiency Grade (FEG)

- Being adopted in Standards/Codes



- Fan Energy Index (FEI)

- DOE Regulation (in holding pattern)
- AMCA is developing a Certified Ratings Program
- CEC Regulation – Likely to pick up on DOE work



Fan Energy Index (FEI)

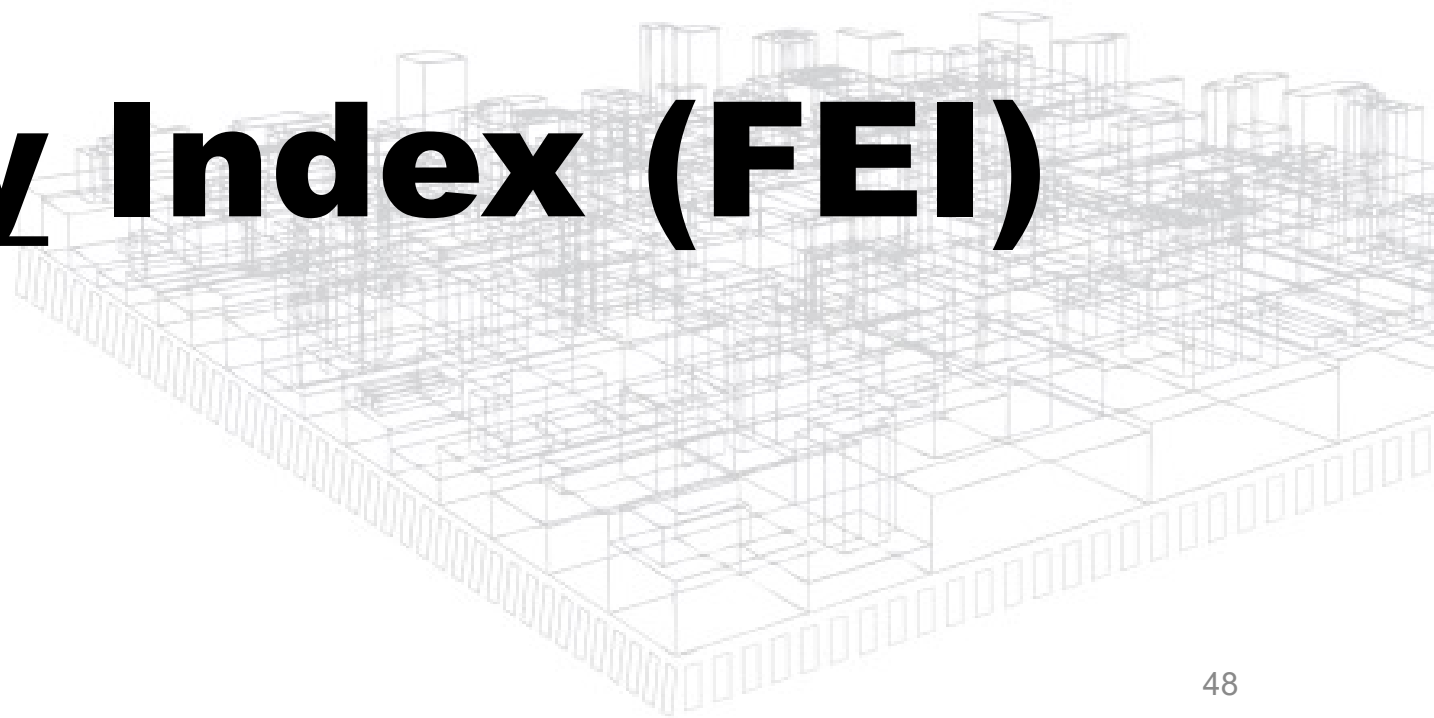

Fan Energy Index (AMCA 208)

$$\text{FEI} = \frac{\text{Fan Efficiency (W2A)}}{\text{Reference Fan Efficiency}}$$

$$\text{FEI} = \frac{\text{Reference Fan Power}}{\text{Fan Power}}$$

$$\text{FEI} = \frac{\text{FEP}_{\text{REF}}}{\text{FEP}_{\text{ACT}}} = \frac{\text{Reference Fan Elect Input Power (kW)}}{\text{Actual Fan Elect Input Power (kW)}}$$

Fan Energy Index (FEI)

FEI varies along the fan curve

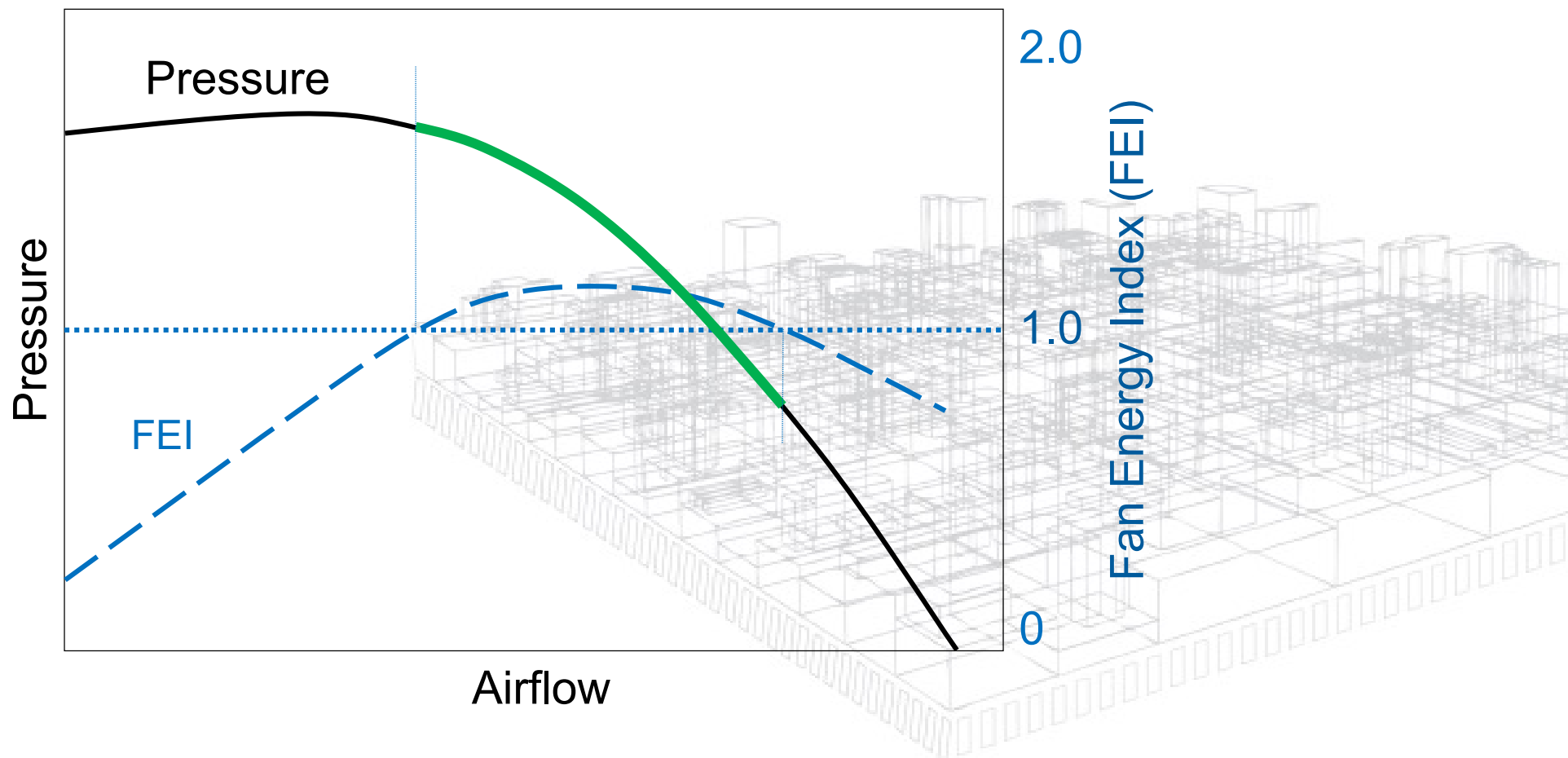

Fan Selection to Reduce Energy

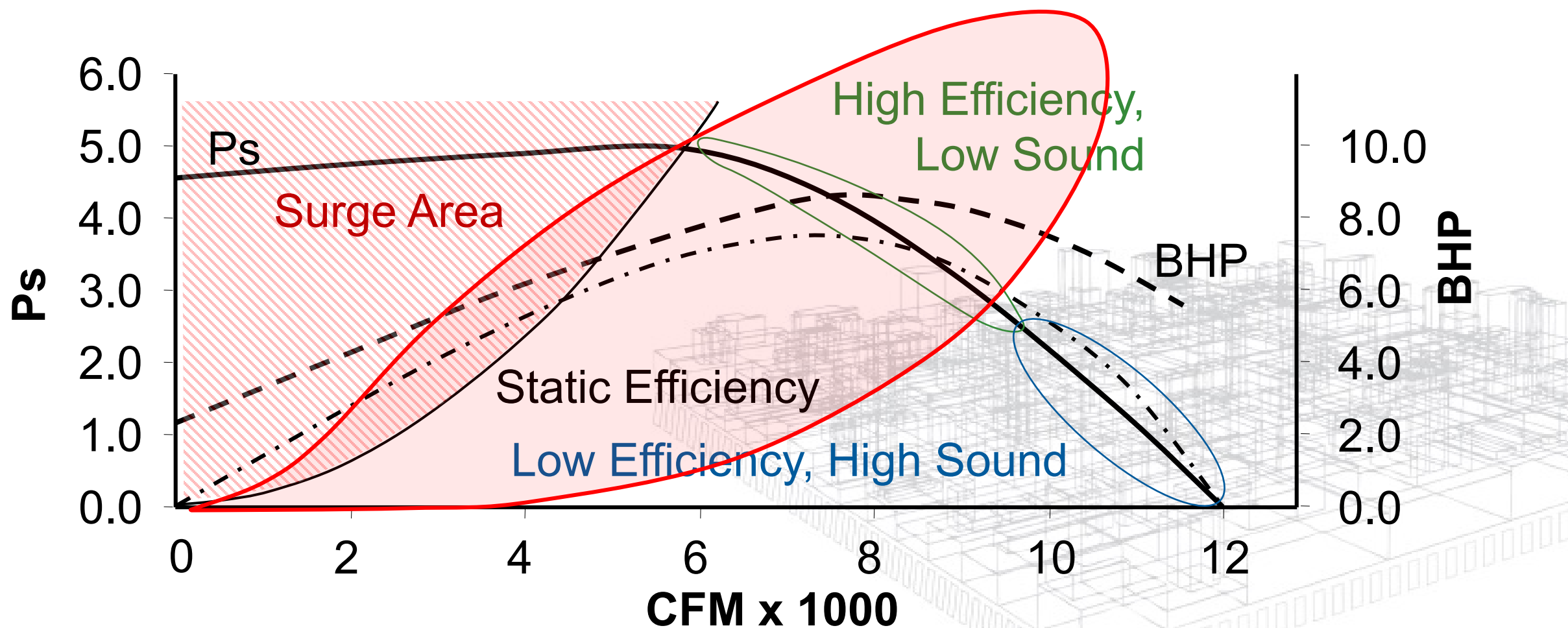

Total Annual Sales Fans Sold Sales June, 2011 – May, 2012

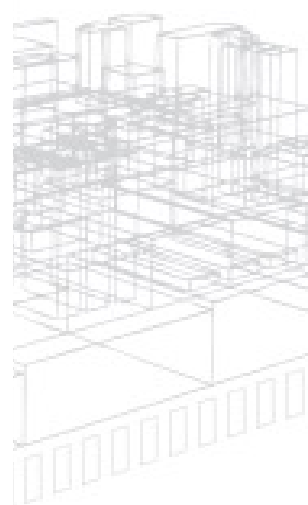
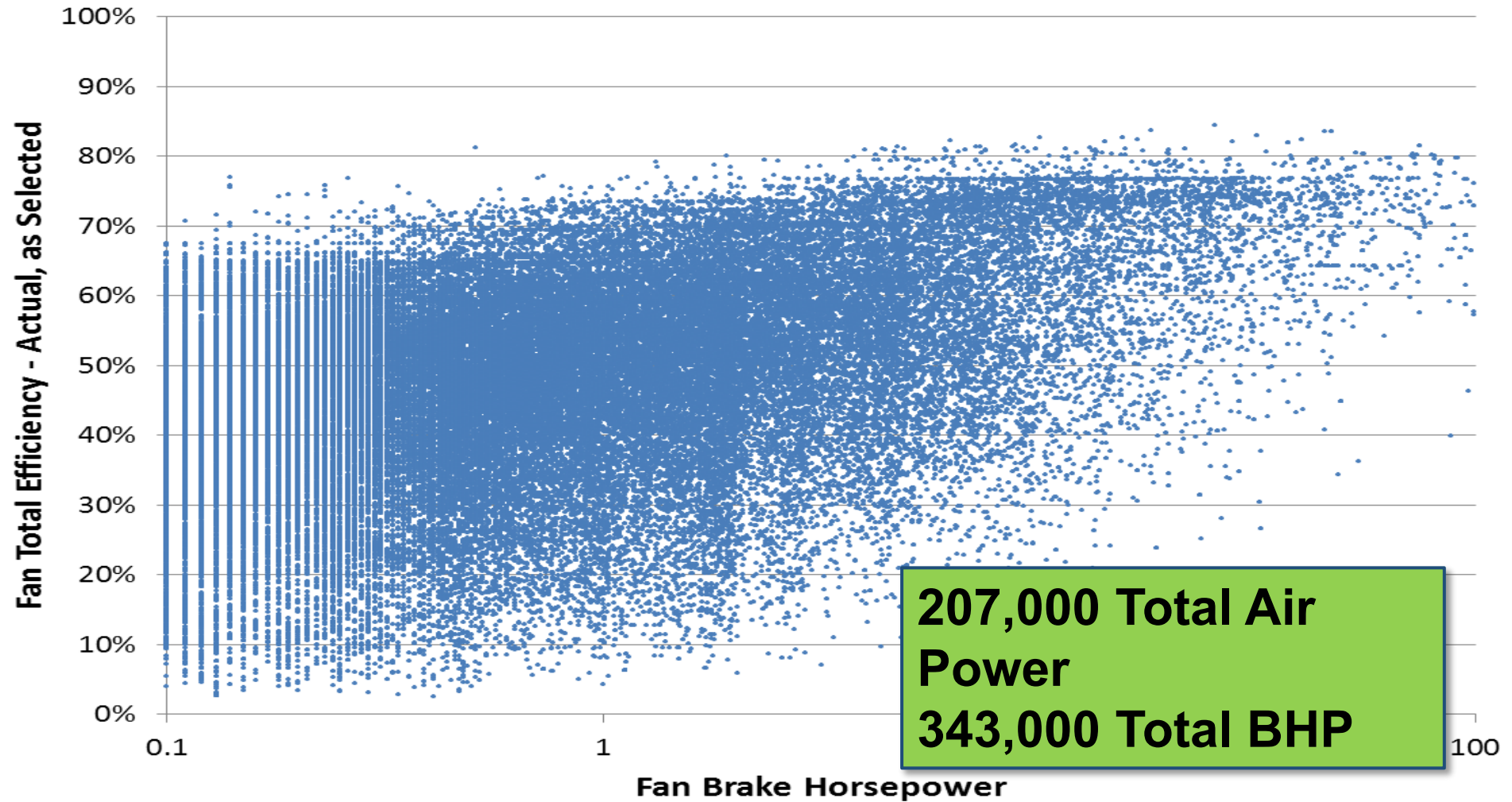

Impact of Selection-Based Efficiency Limits

Fans Sold June, 2011 – May, 2012

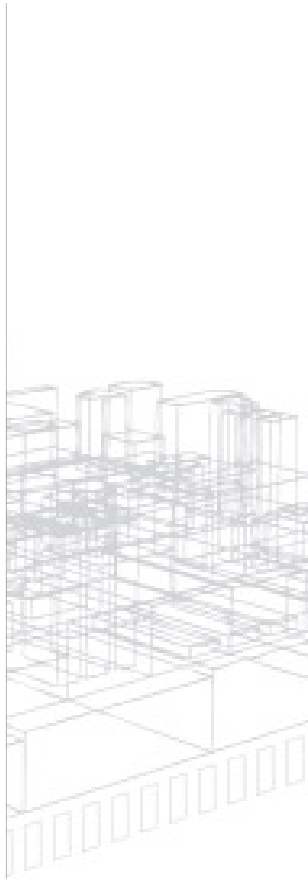
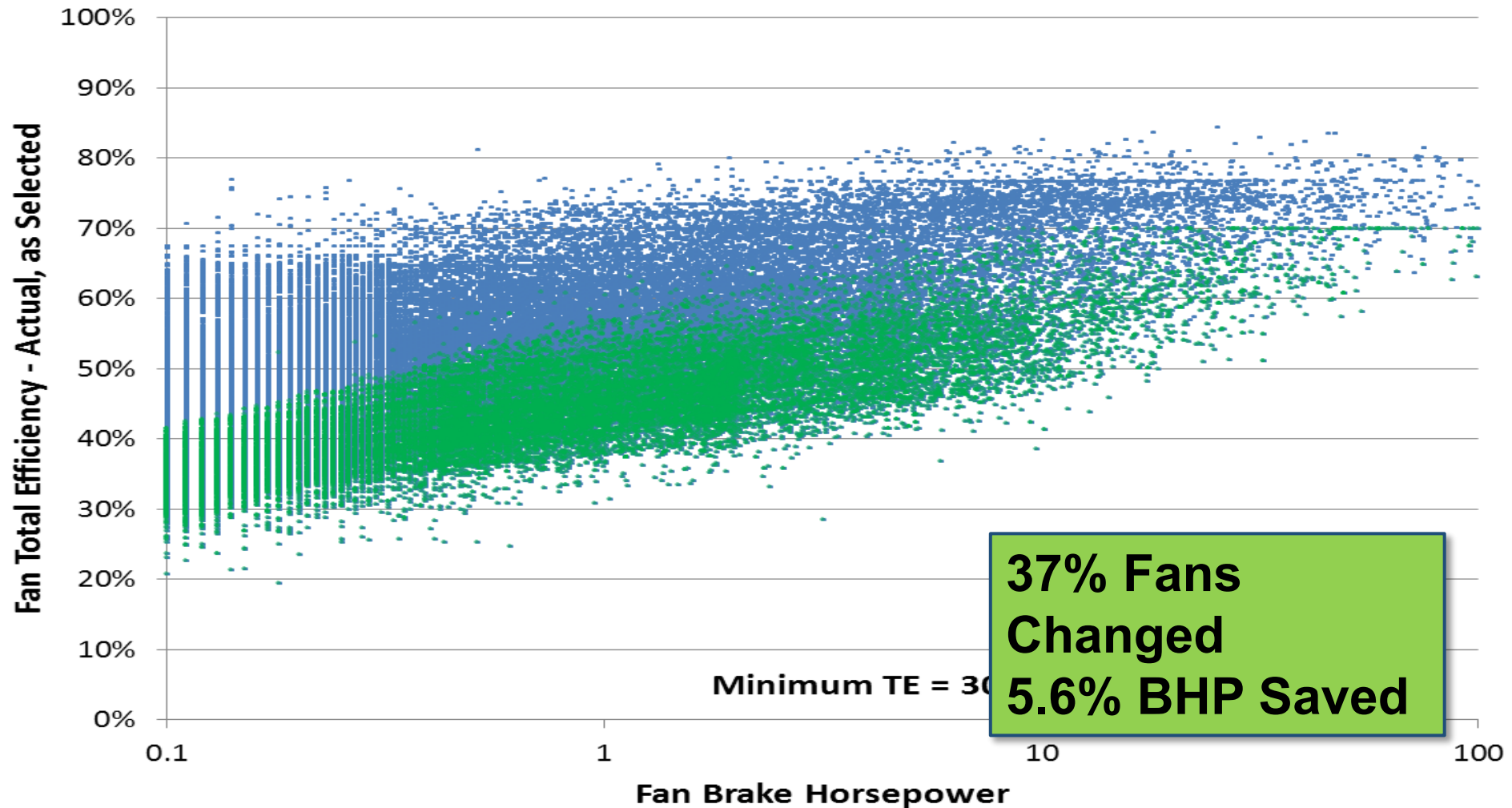

What does this mean to Fan Selections?

Multiple Speed Fan Performance Curves
"Relatively High Efficiency Fan" – Large selection area

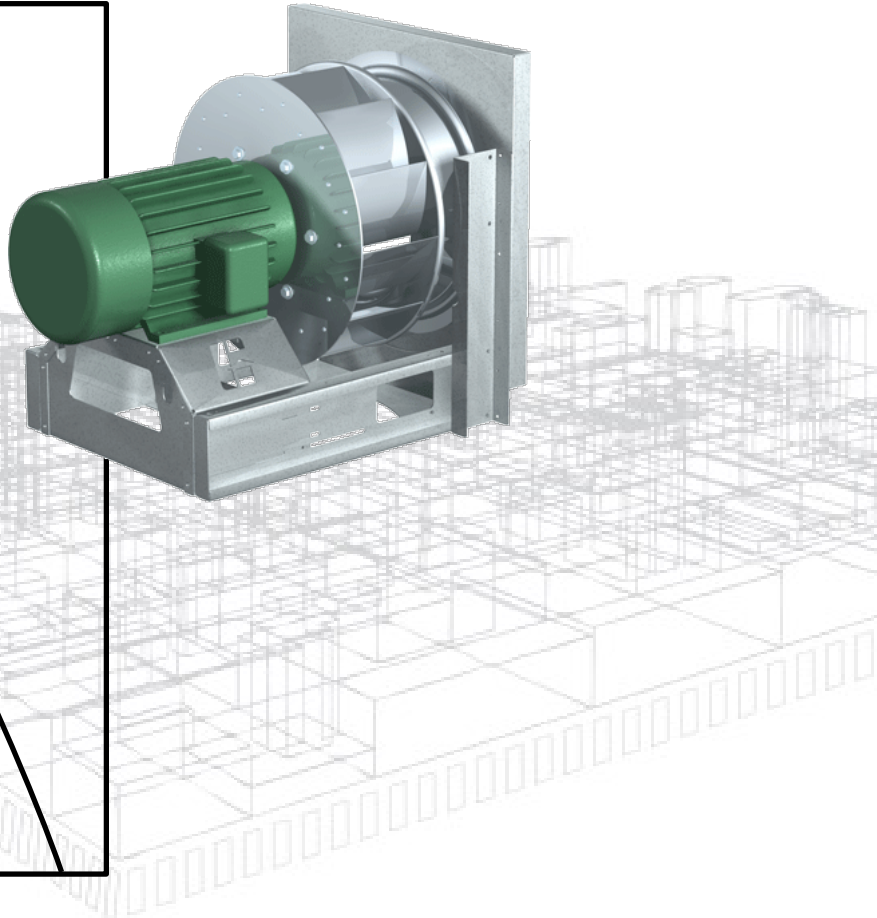
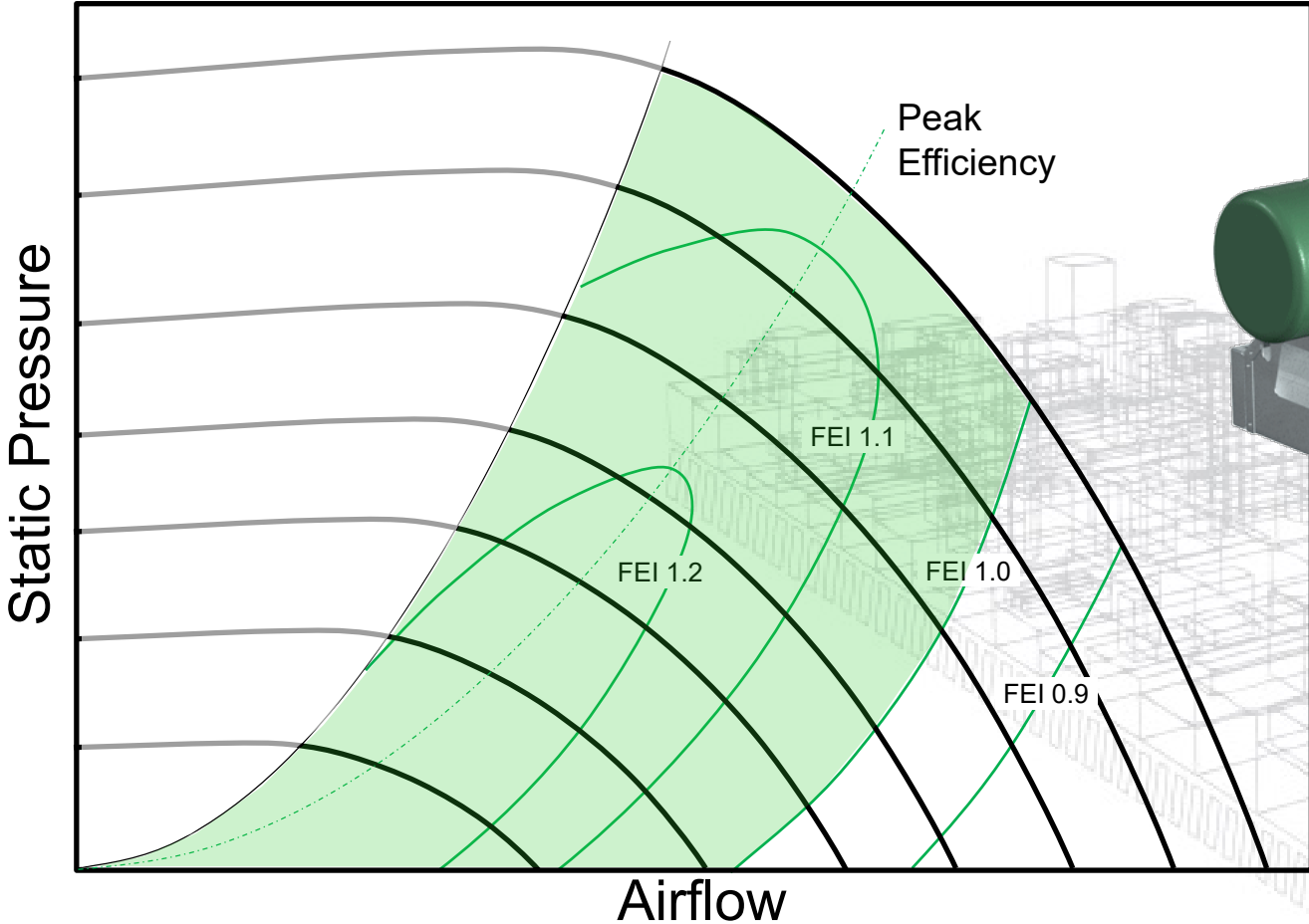

What does this mean to Fan Selections?

Electronic Fan Selection Software based on Total Pressure
Design Point 10,000 CFM at 3.0" Pt

Fan Size (in.)	Fan Speed (rpm)	Fan Power (bhp)	Actual Total Efficiency	Baseline Power (bhp)	Baseline Total Efficiency	FEI
18	3238	11.8	40.1%	7.96	59.4%	0.67
20	2561	9.56	49.5%	7.96	59.4%	0.83
22	1983	8.02	59.0%	7.96	59.4%	0.99
24	1579	6.84	69.1%	7.96	59.4%	1.16
27	1289	6.24	75.8%	7.96	59.4%	1.28
30	1033	5.73	82.5%	7.96	59.4%	1.39
33	887	5.67	83.4%	7.96	59.4%	1.40
36	778	6.01	78.7%	7.96	59.4%	1.32

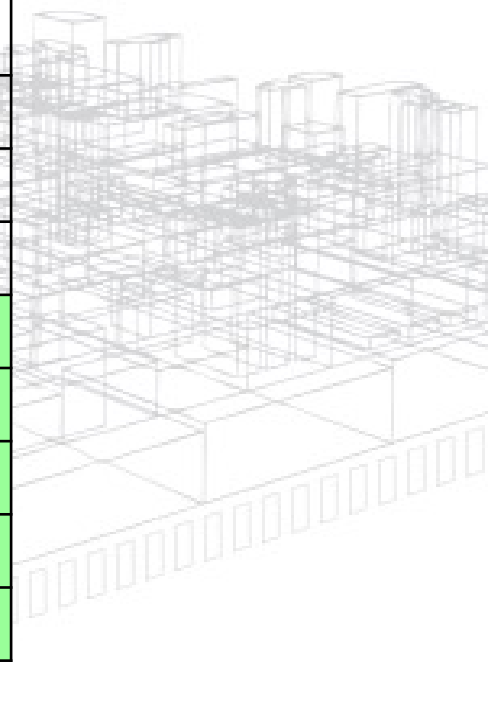

Product Case Study

Design Point: 15,000 CFM at 0.5" Pt

Fan Model	Design BHP	FEI	Oper Cost (\$/year)	Weight (lbs)	Housing Width	Budget Cost	Payback (years)
Sq Inline 30"	5.33	0.62	\$1363	571	46"	\$3300	-
Sq Inline 42"	2.92	1.12	\$758	735	58"	\$4050	1.22
Mixed Flow 27"	2.77	1.18	\$719	611	41"	\$6700	5.28
EQB-27	2.83	1.16	\$734	451	41"	\$3900	0.95



30" Sq Inline



42" Sq Inline

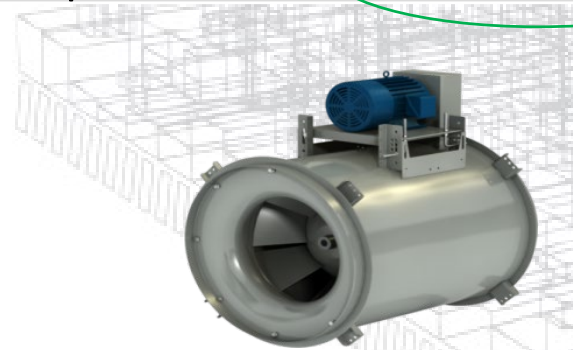

27" Mixed Flow



27" VE Mixed
Flow

Is FEI a Good Fan Energy Regulation?



1. Saves Energy



2. Applies to all fans
A. Promote Proper Selection
B. Encourage Substitution



3. Prevents Loopholes

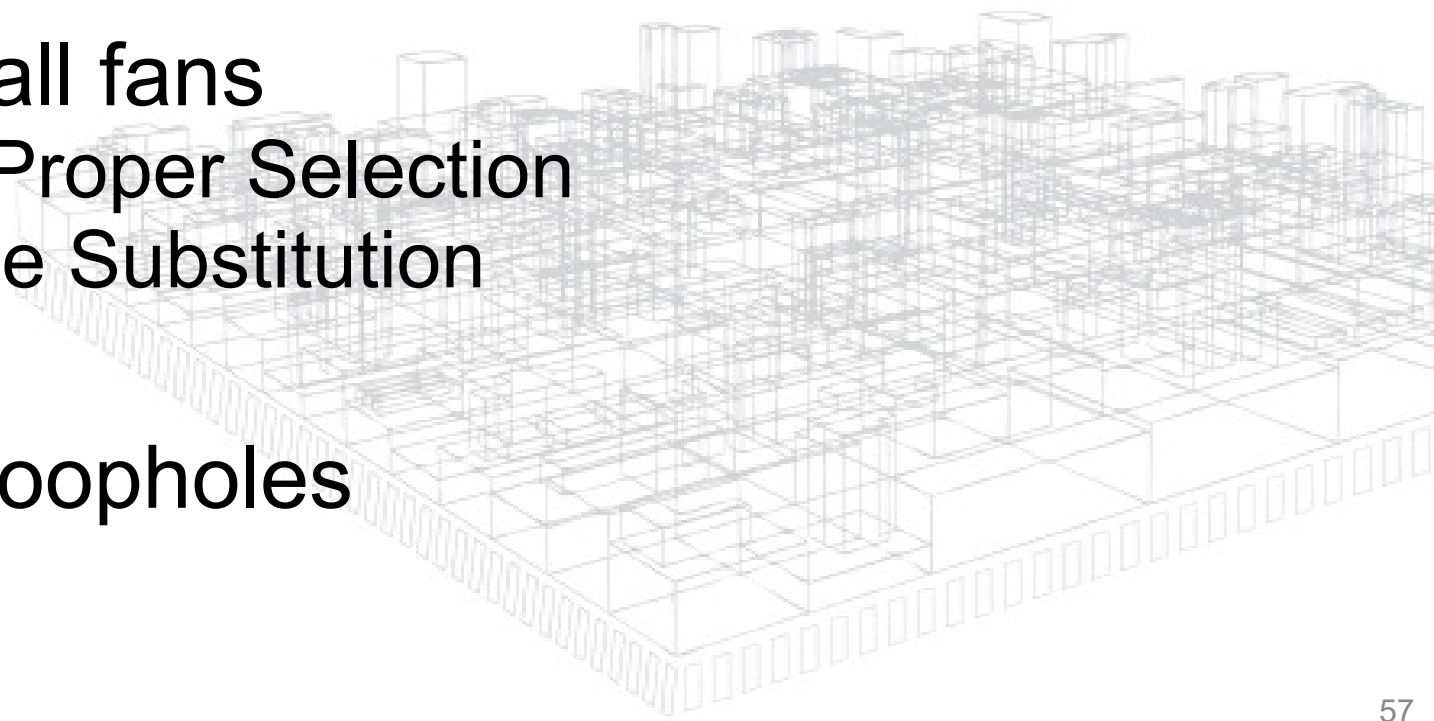

Benefits of Fan Energy Index(FEI)

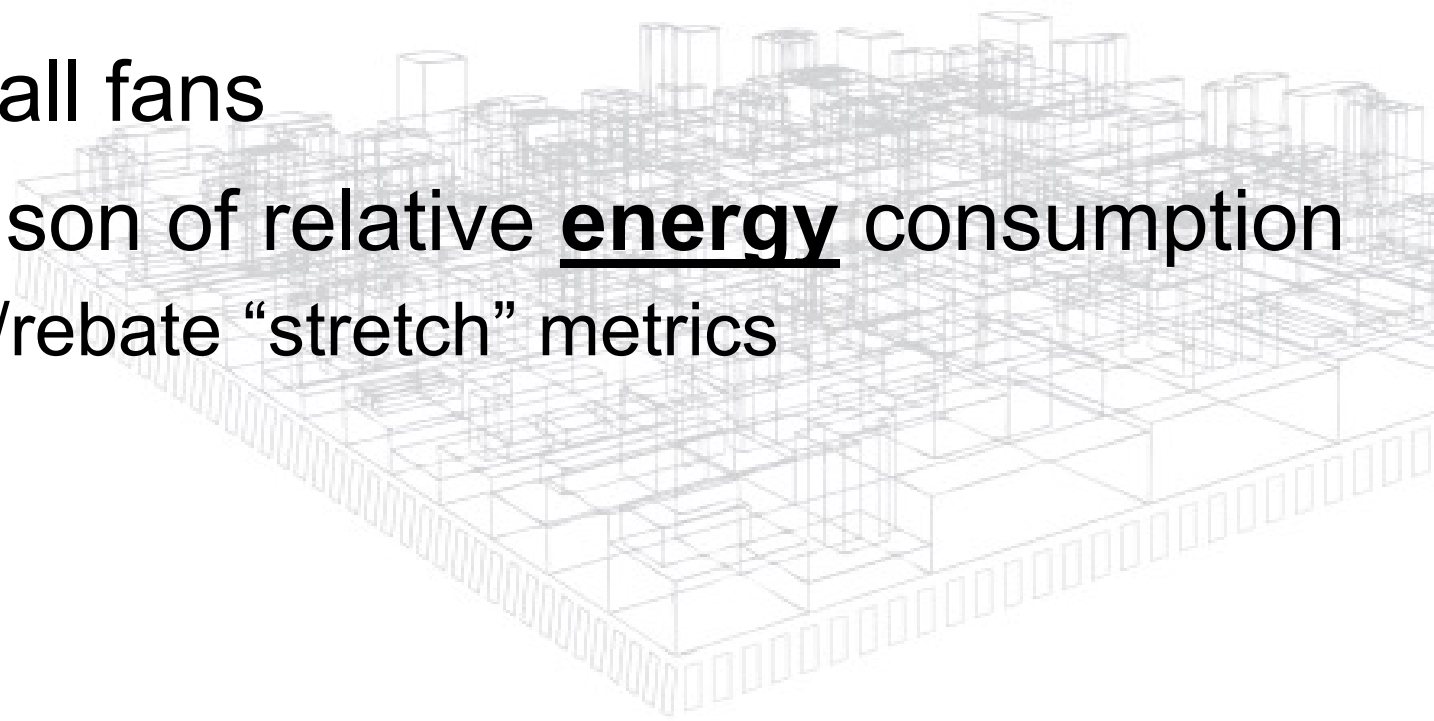
1. FEI will drive energy savings 2 ways:
 - A. Manufacturers will improve Fan Designs
 - B. System designers can make better Fan Selections
 2. FEI can be used with all fans
 3. FEI is a good comparison of relative energy consumption
 - A. Can be used to incent/rebate “stretch” metrics
- 

Fan Energy Index - Applications

How will FEI be used?

Body	FEI Requirement
Federal Regulation	FEI \geq 1.0 at Design Point
ASHRAE 90.1	FEI \geq 1.0 at Design Point
ASHRAE 189.1	FEI \geq 1.1 at Design Point
Rebates	FEI = Savings over Baseline

FEI = 1.10 means 10% energy savings over baseline

Summary – Fan Energy Metrics

- **FEG & FMEG – Based on peak fan efficiency**

“How good is the fan?”

- **FEI – Based on fan input power as applied**

“How good is the fan for its application?”

Fan selection process is key to energy savings!

The market will demand more efficient fans!

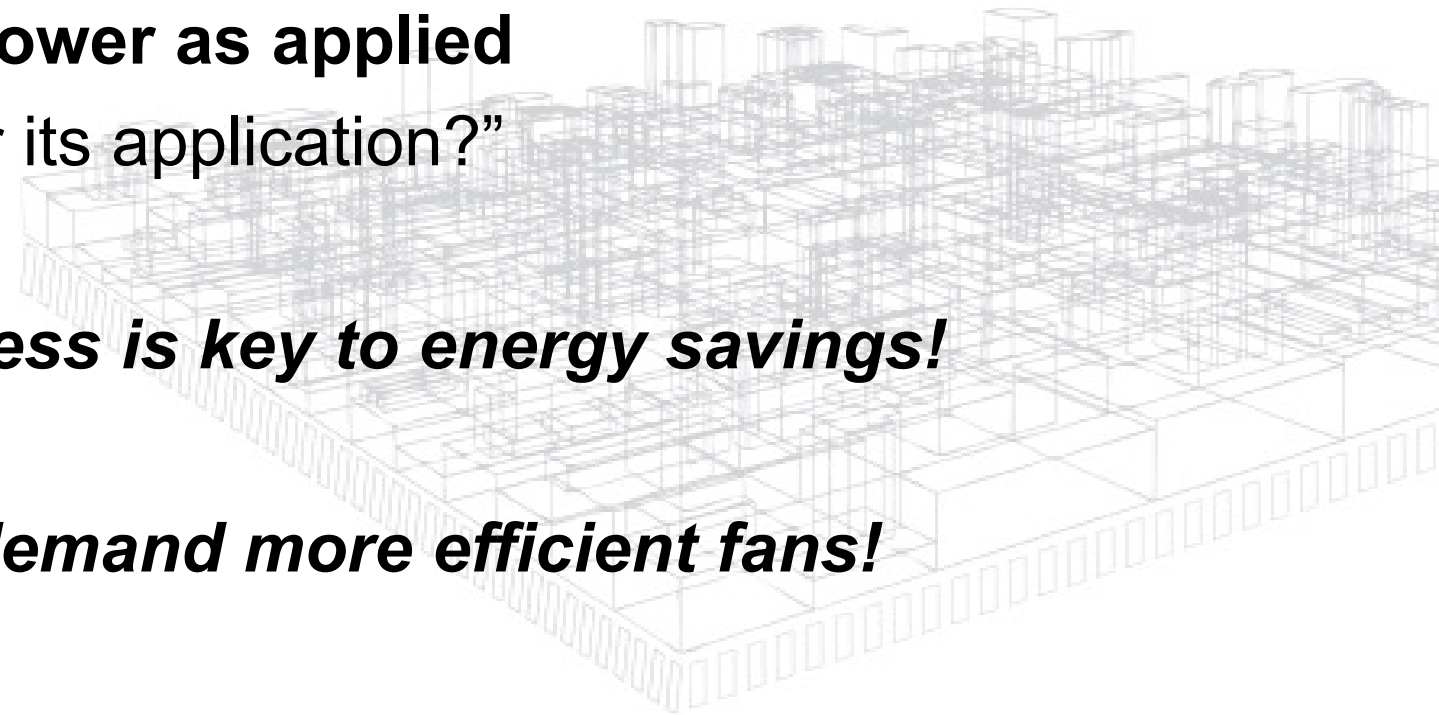

Summary Fan Energy Regulation

- Fan *Efficiency* Grade (FEG)

- AMCA CRP will be discontinued
- ASHRAE 90.1-2019 will replace FEG

- Fan *Energy* Index (FEI)

- Expect AMCA CRP Products by 2019
- Expect FEI in ASHRAE 90.1-2019
- Expect CEC Title 20/24 by 2022



Questions?

Mike Wolf, PE
Greenheck, Schofield, WI
mike.wolf@greenheck.com
715-355-2380