



AMCA International

# VAV System Design Tips

**Steve Taylor, PE, FASHRAE**

Principal, Taylor Engineering LLC, Alameda, CA

[staylor@taylor-engineering.com](mailto:staylor@taylor-engineering.com)

**Air System Engineering & Technology (ASET) Conference-US**

San Antonio, TX • Hyatt Regency San Antonio Riverwalk • March 6 - 7, 2018

# Professional Development Hours (PDH) Certificates

The Air Movement and Control Association International (AMCA), has met the standards and requirements of the Registered Continuing Education Providers Program. Credit earned on completion of this program will be reported to the RCEP. A certificate of completion will be issued to each participant. As such, it does not include content that may be deemed or construed to be an approval or endorsement by NCEES or RCEP.



# Copyright Materials

This educational activity is protected by U.S. and International copyright laws. Reproduction, distribution, display, and use of the educational activity without written permission of the presenter is prohibited.

© AMCA International

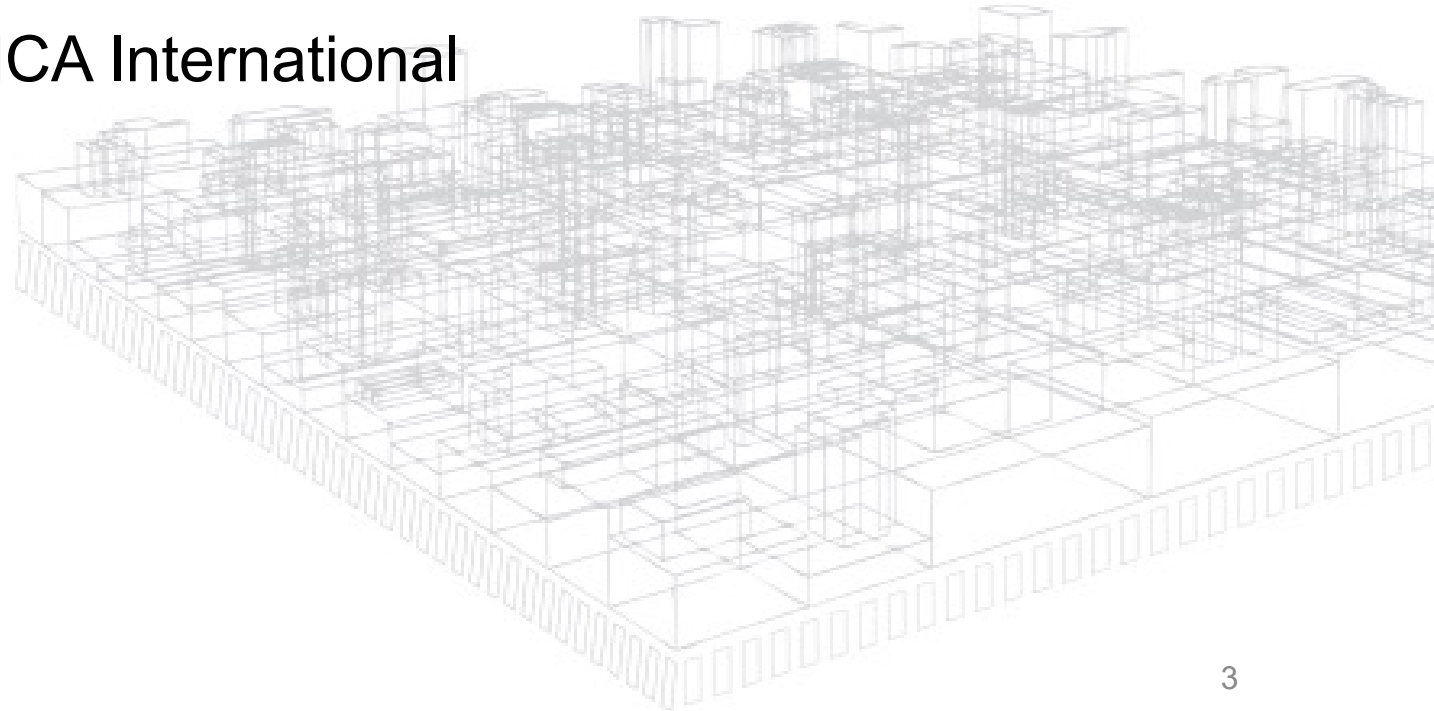

# Learning Objectives

- Learn some tips to improve VAV system performance
- Become familiar with very recent changes to Standard 62.1 and how they affect minimum VAV box setpoints
- Learn how fan arrays can reduce costs and improve performance
- Learn how best to measure and control minimum outdoor airflow

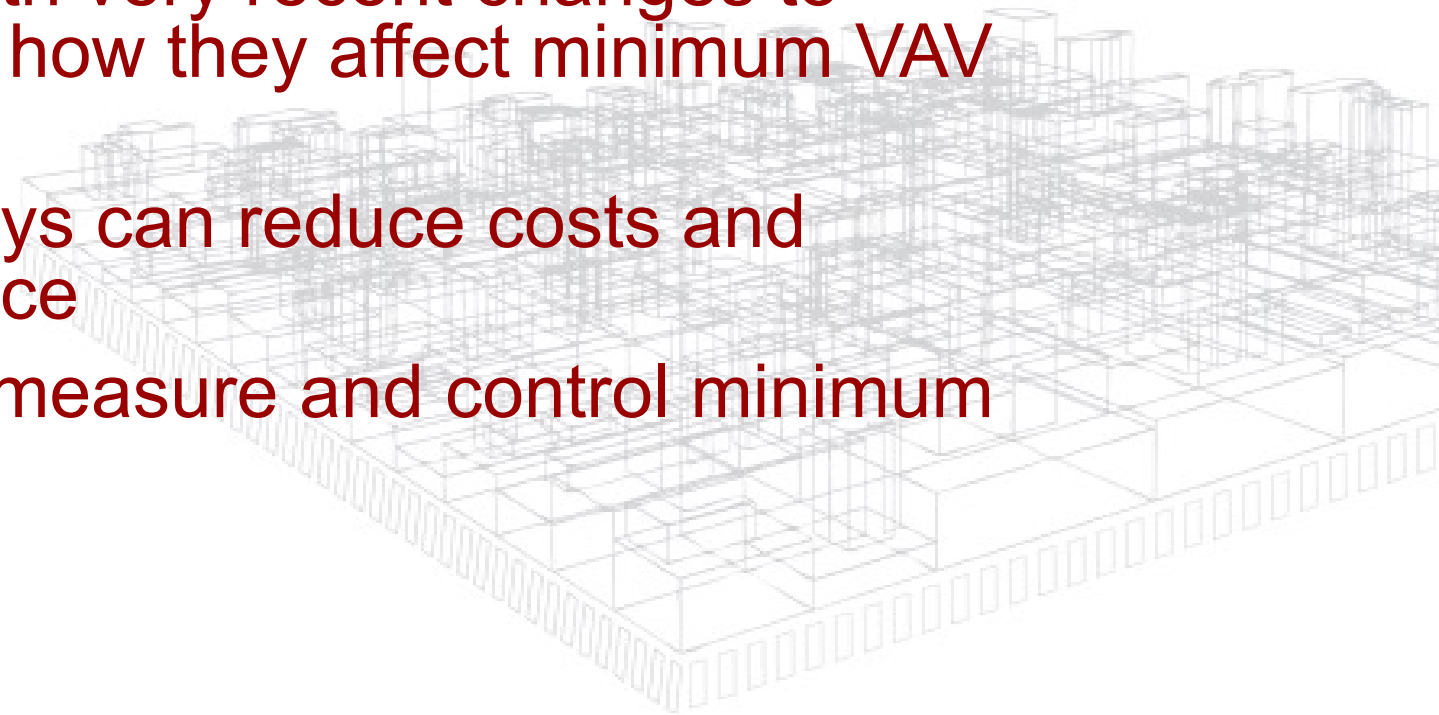

# Agenda – VAV Design Tips

- Tip#1: Use ASHRAE Guideline 36 Sequences
- Tip#2: Set VAV Box minimum airflow to minimum ventilation rate
- Tip#3: Use Fan Arrays
- Tip#4: Control minimum outdoor air using DP across fixed orifice

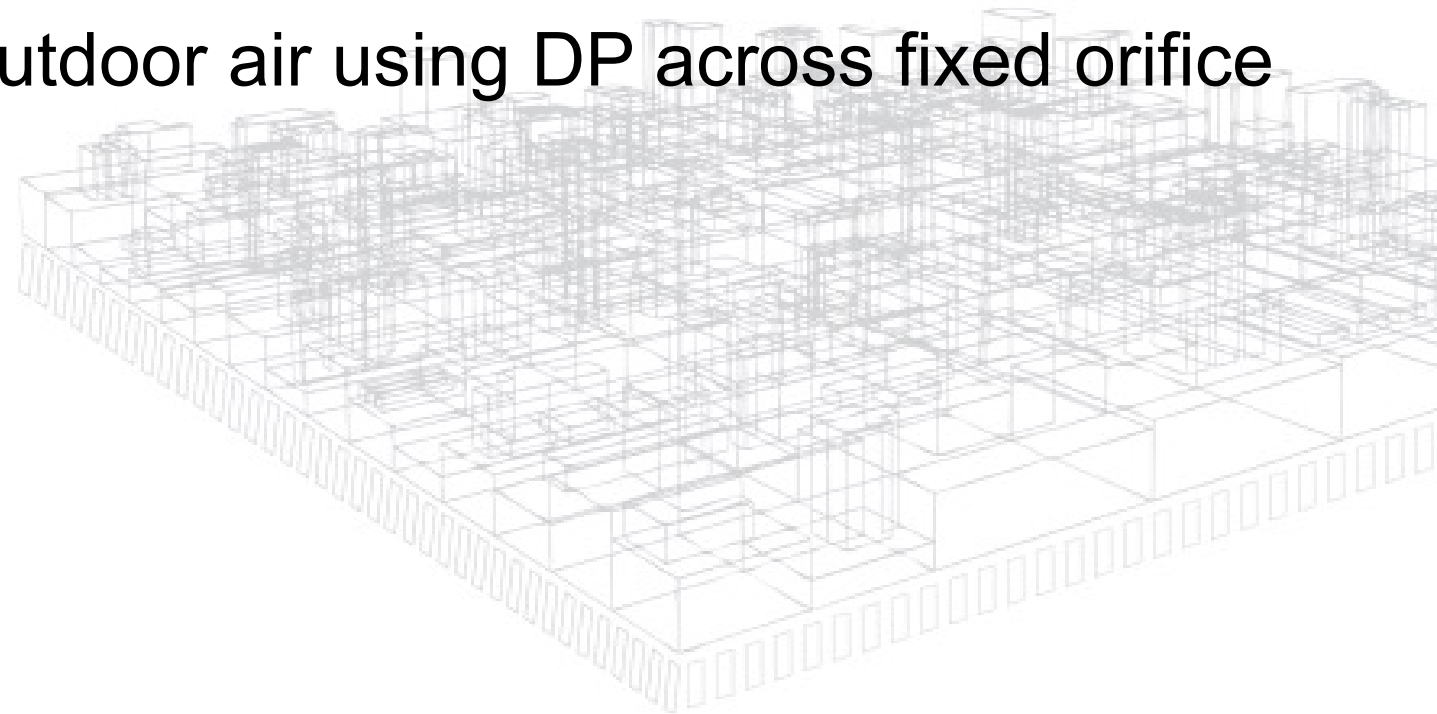

# **Tip#1: Use ASHRAE Guideline 36 Sequences**

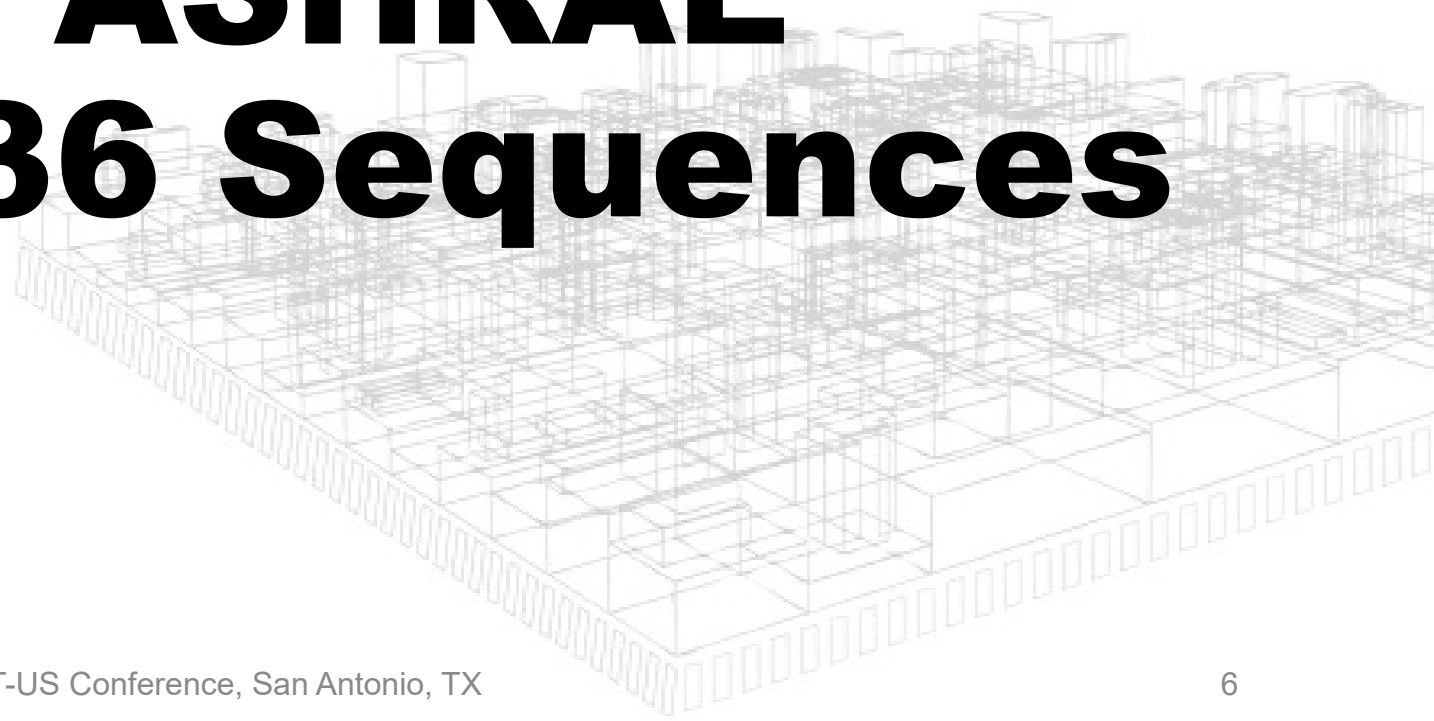

# ASHRAE Guideline 36

- New Guideline with best-of-class Sequences of Operation
- The Goal:
  - ASHRAE experts create and maintain advanced sequences
  - Manufacturers preprogram, test, and debug all the sequences for their dealers
  - Engineers simply spec: “Use ASHRAE Guideline 36 sequences”
  - Control contractors simply use the preprogrammed sequences from their vendor
  - Commissioning agents use the functional performance tests included (eventually) with Guideline 36



ASHRAE Guideline 36-2018

## High Performance Sequences of Operation for HVAC Systems

# Example: “Dual Max” VAV Control

## VAV Boxes with Reheat

### Conventional VAV Control

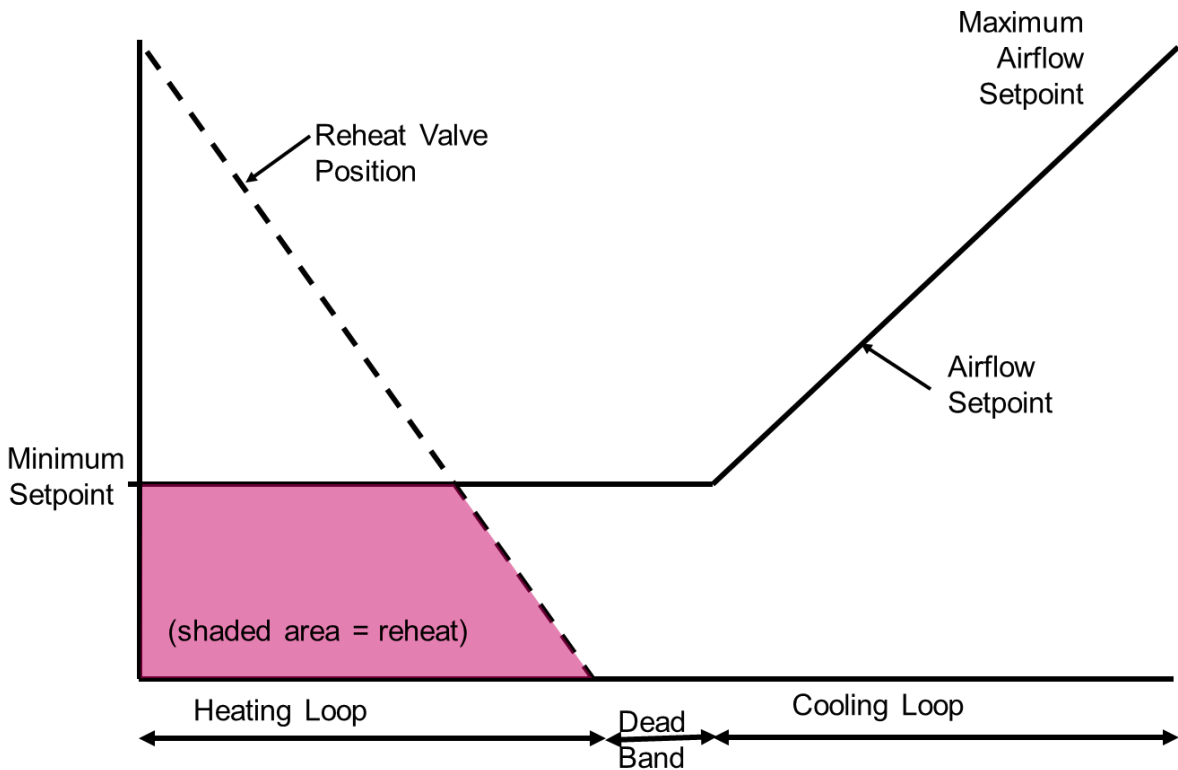

### Dual Maximum VAV Box Logic

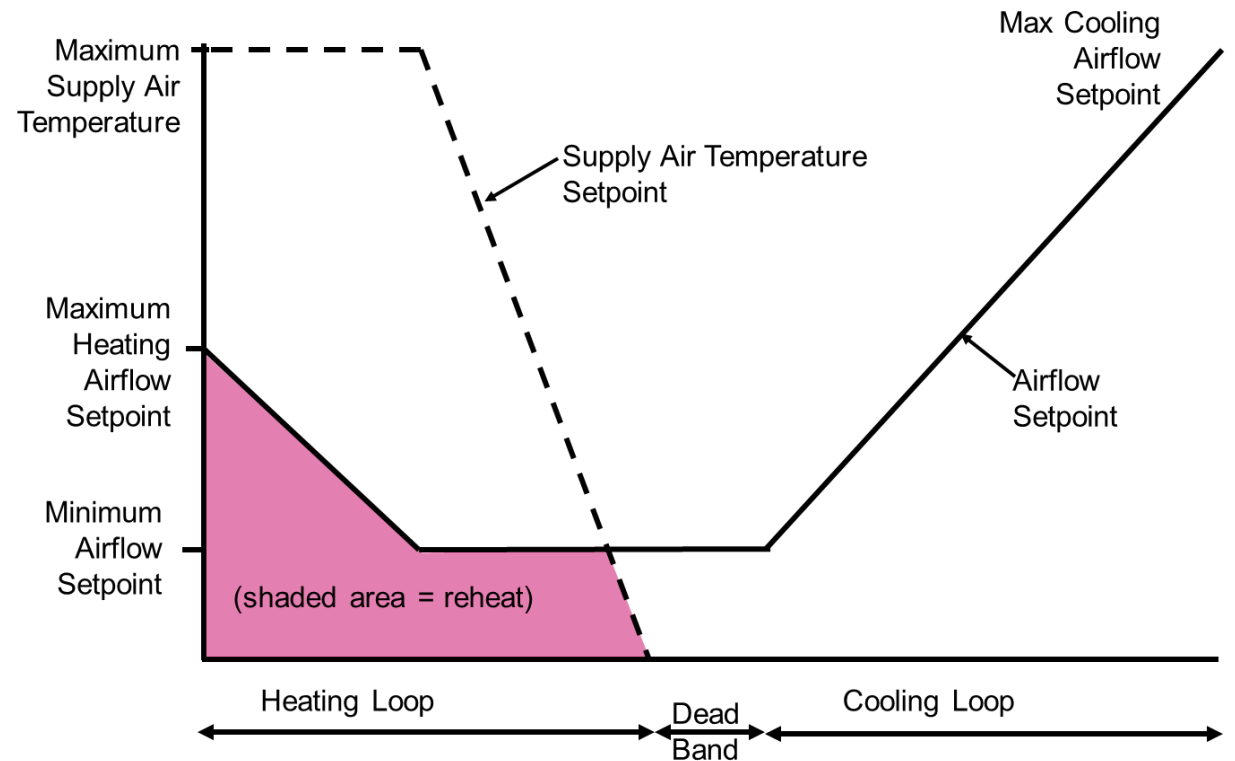



# RP-1515: Loads are very low!

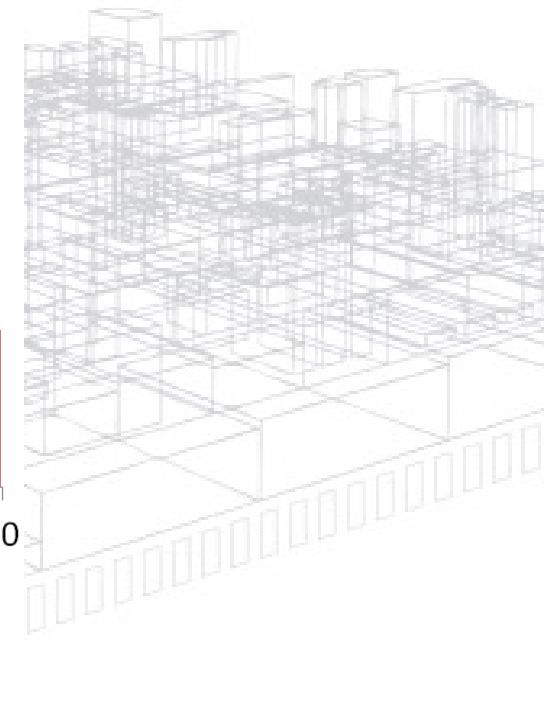
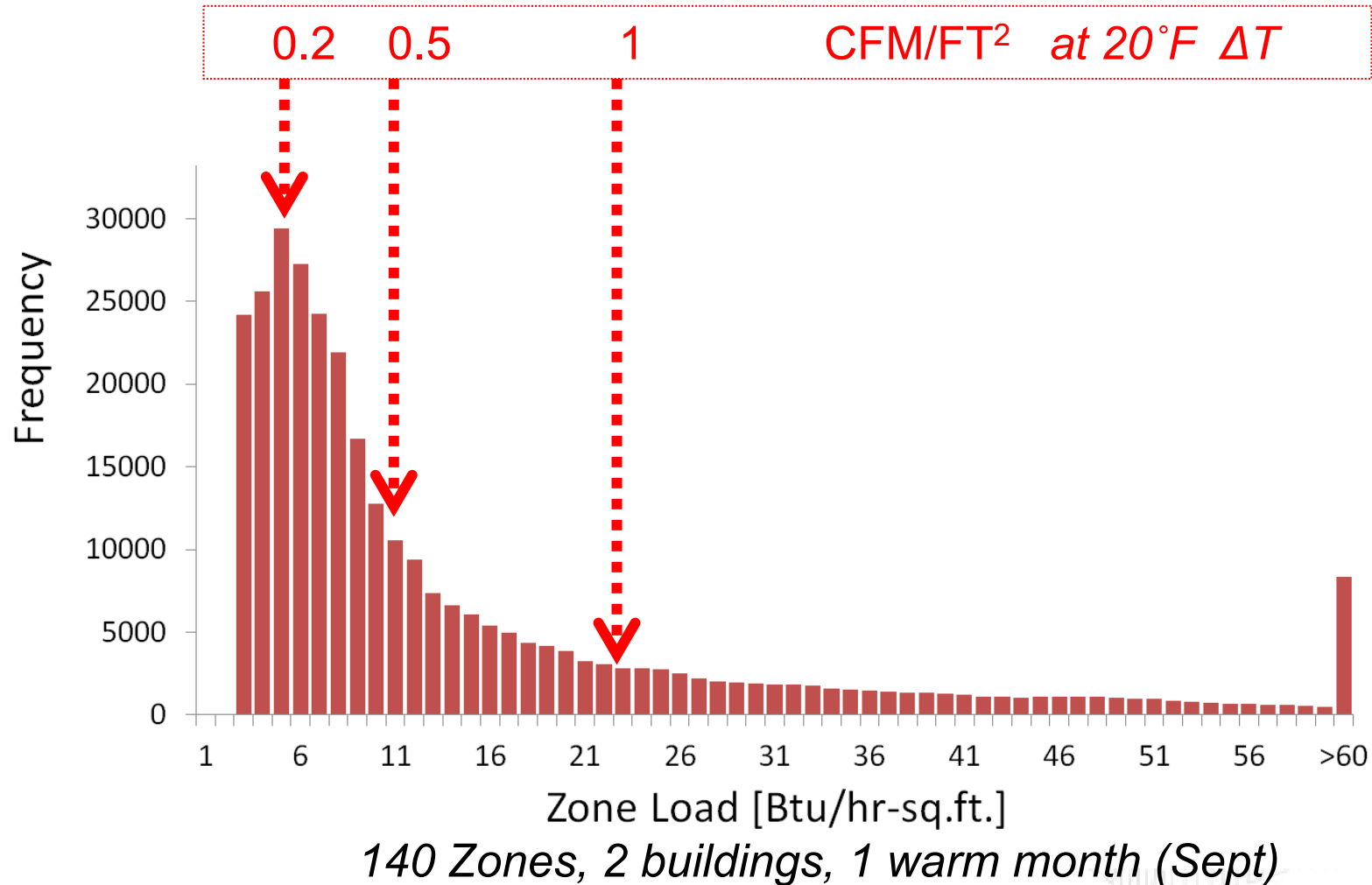

# RP-1515: Measured flow fractions

Warm Season All Occupied

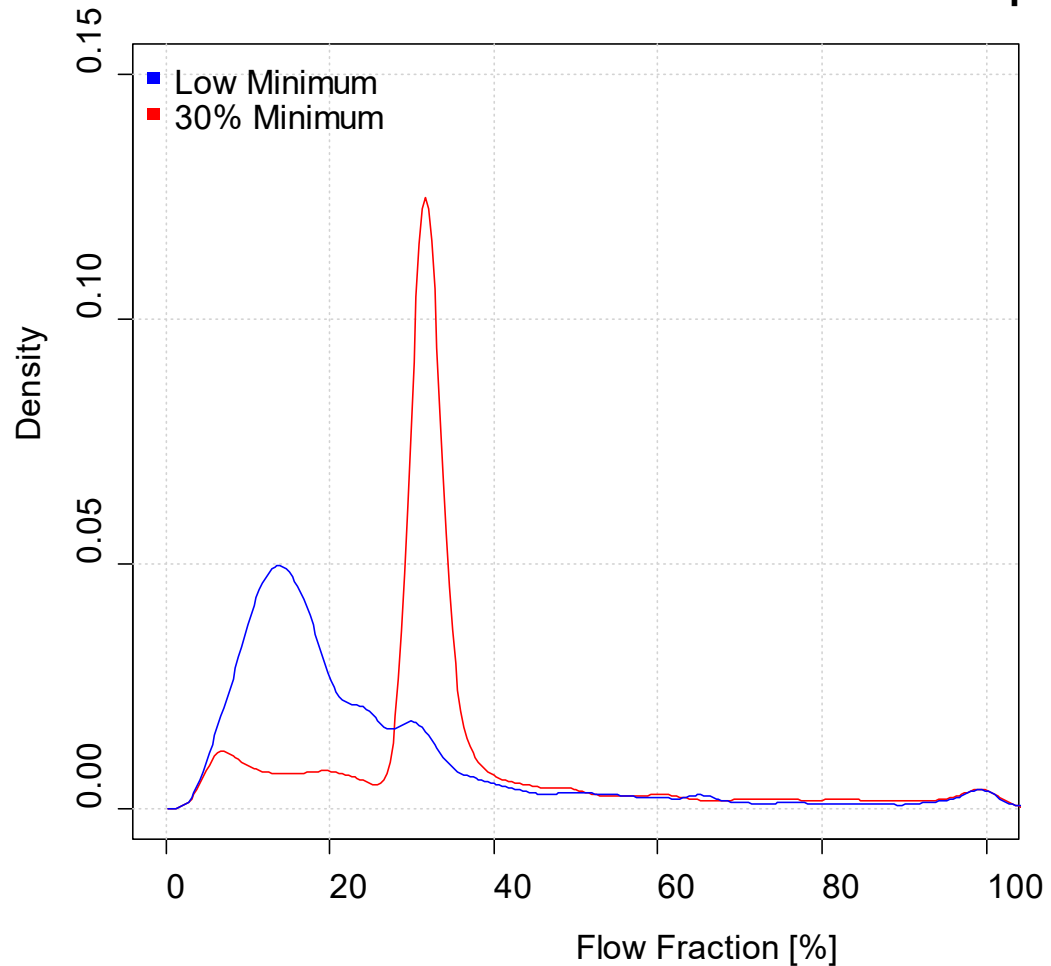

Cool Season All Occupied

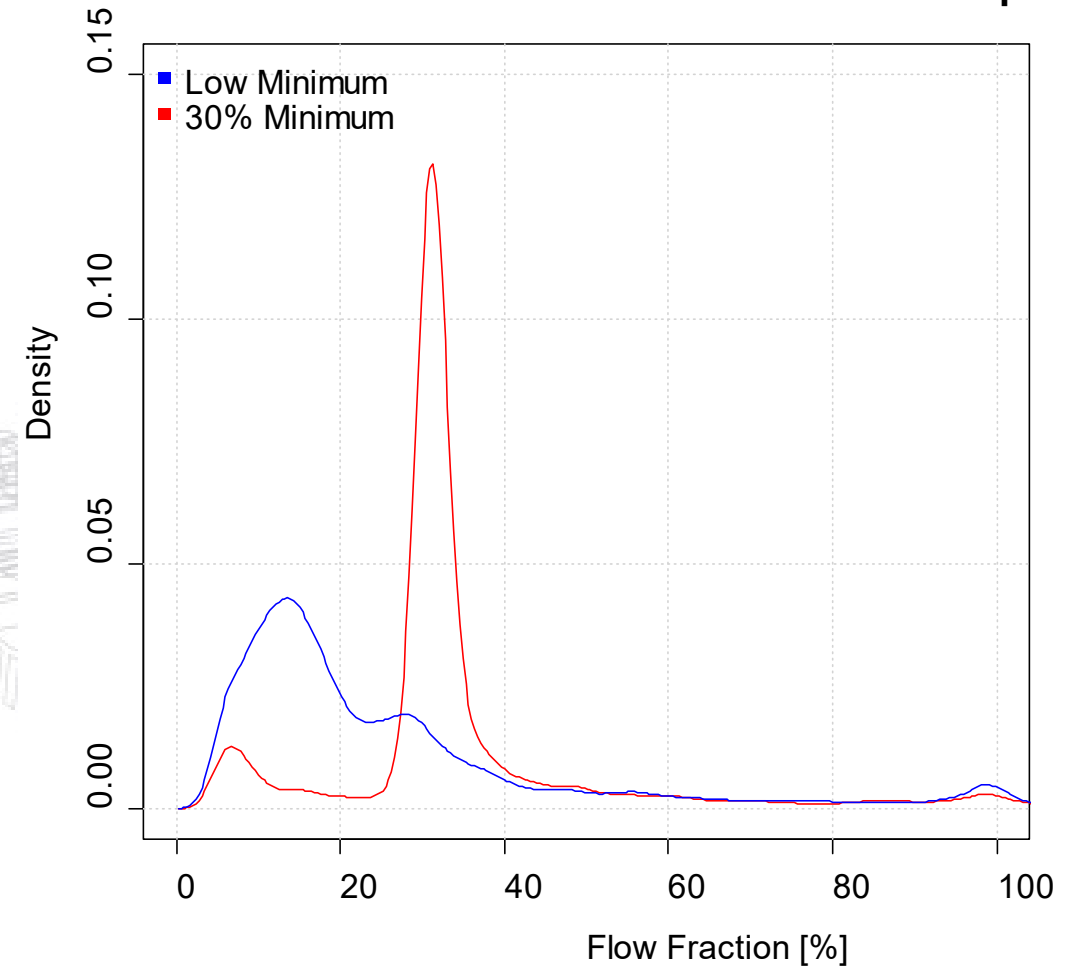

# RP-1515 Comfort Survey

"How satisfied are you with the temperature in your workspace?"

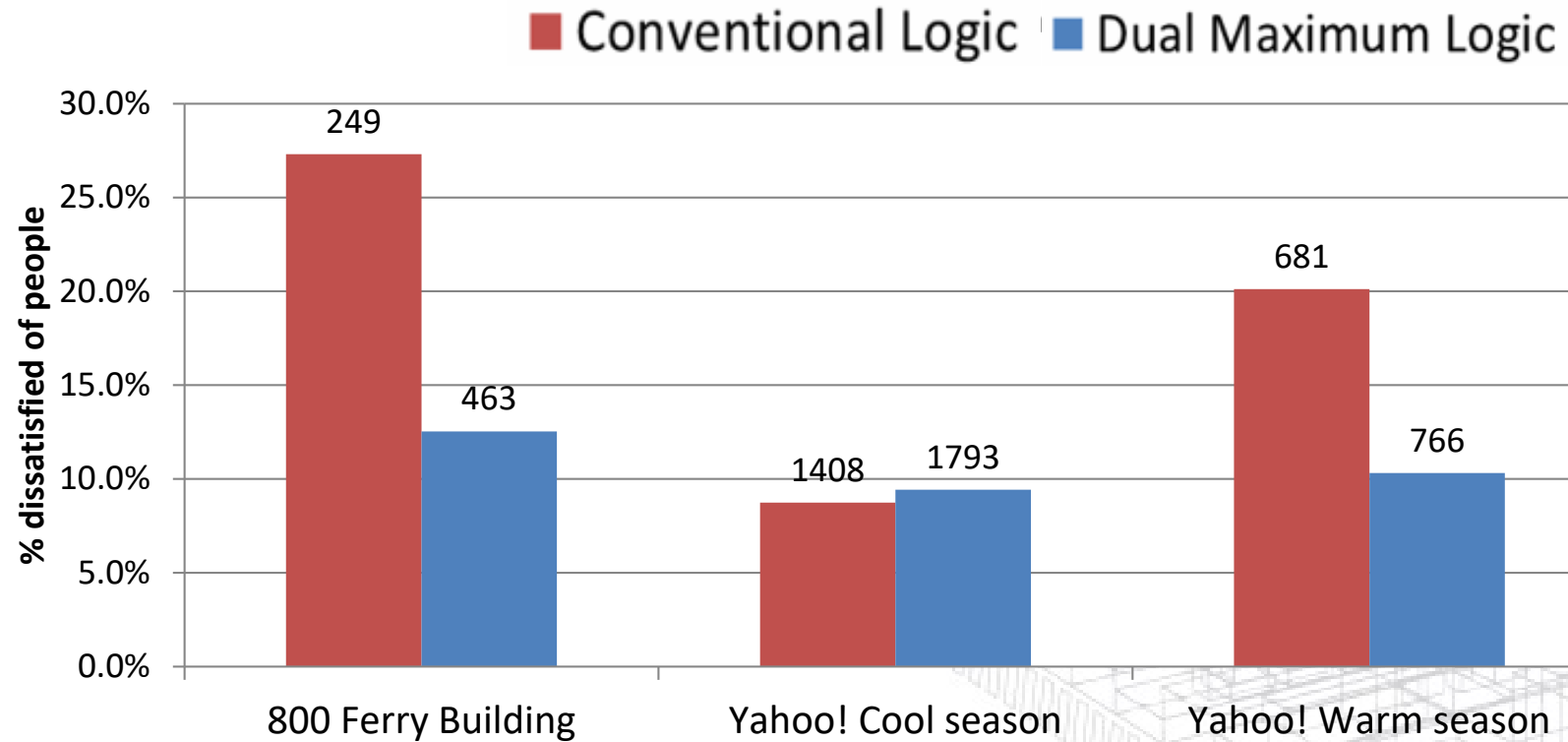

# What happens when load is less than minimum airflow setpoint?

Conventional Logic

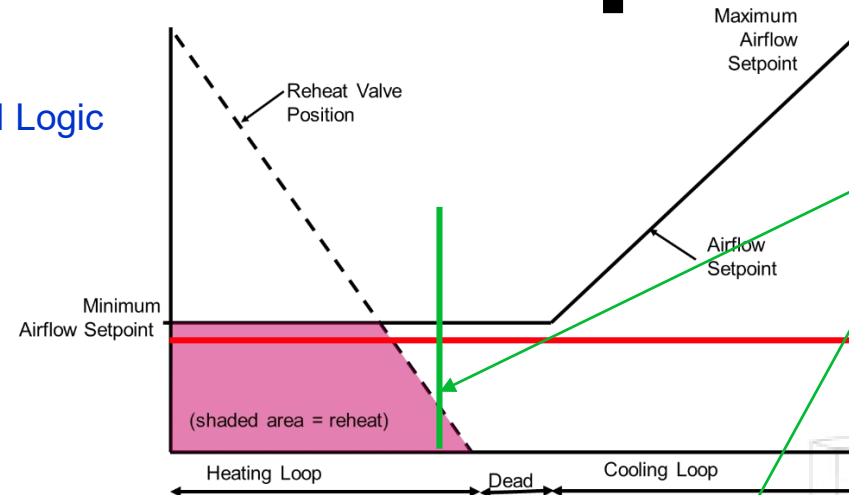

Resulting Loop (~temperature)

Dual Max Logic

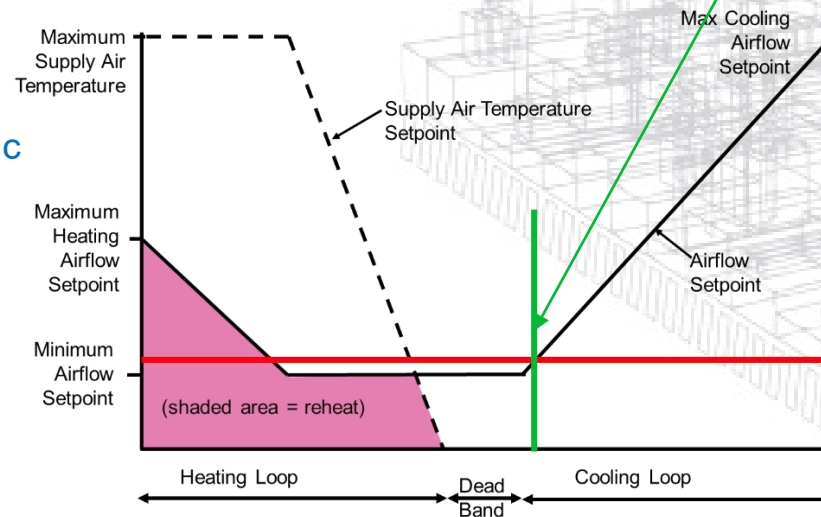

Actual Required CFM

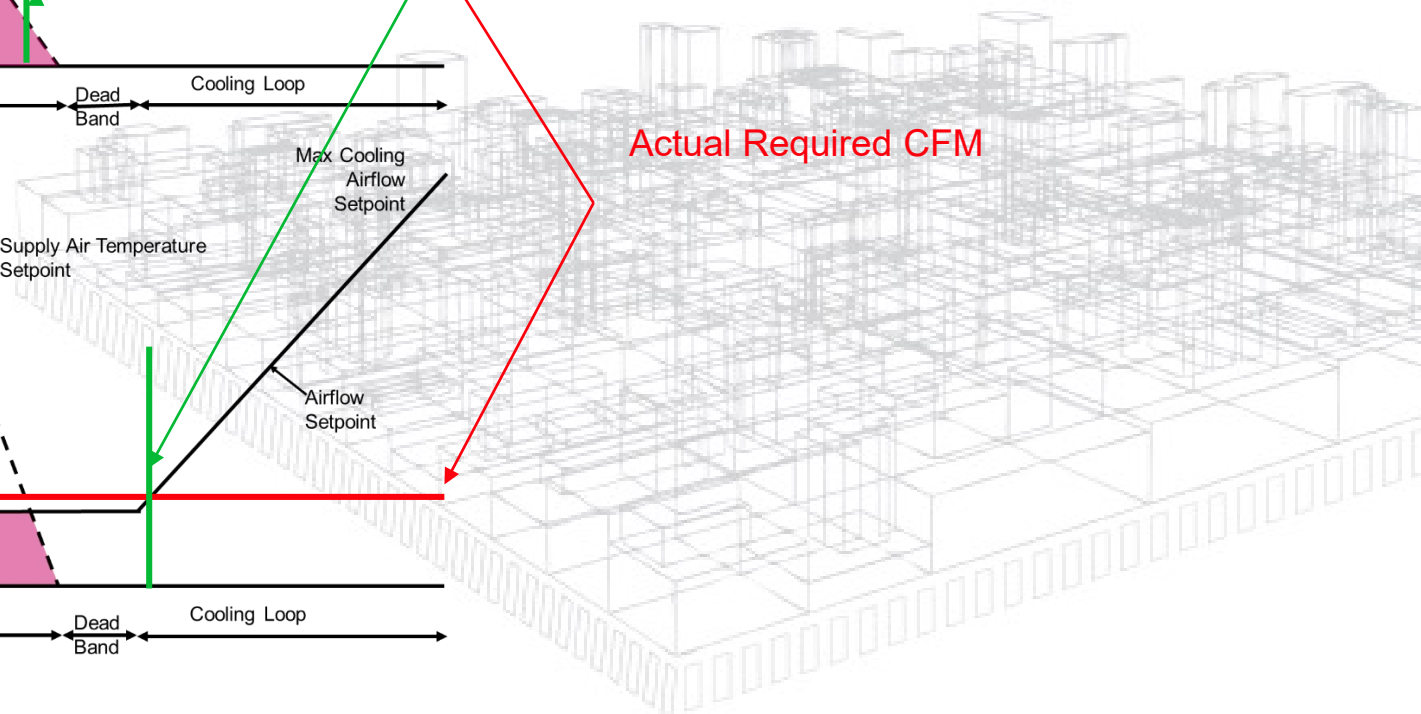

# RP-1515 How about Dumping/Drafts? (Building with perforated diffusers)

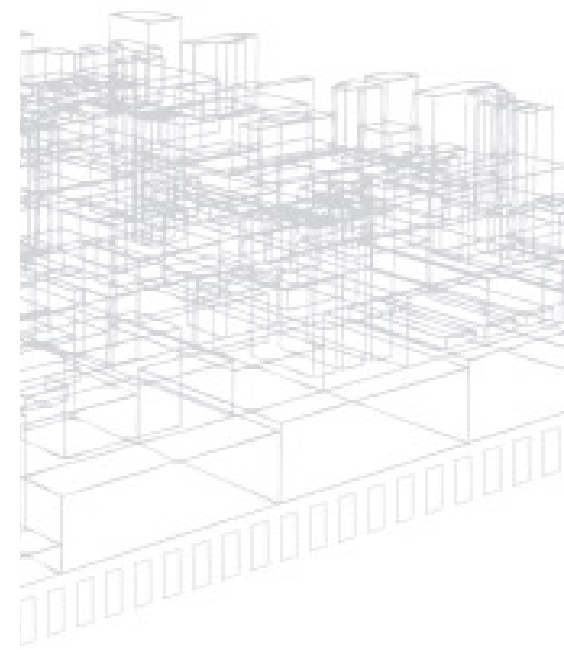
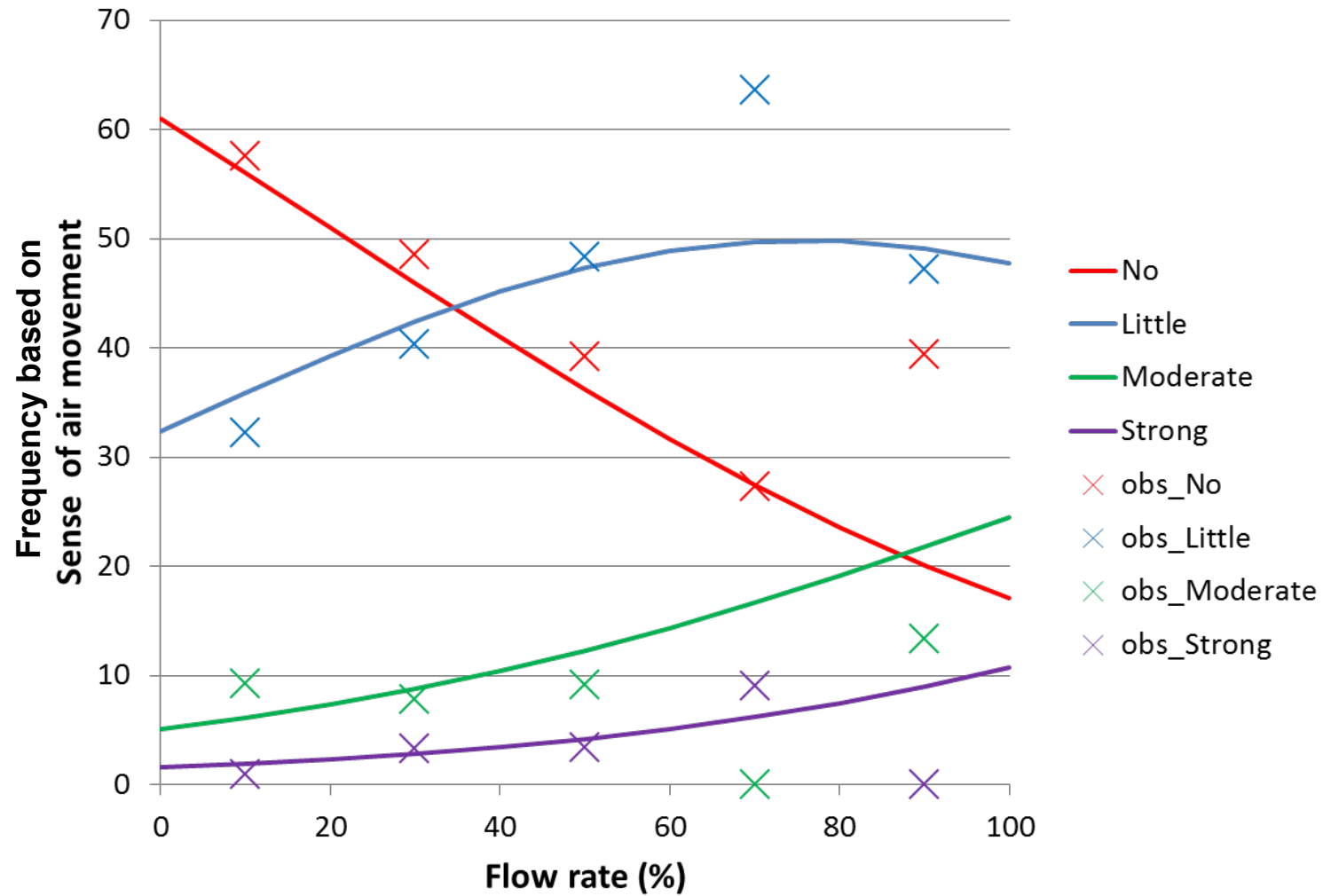

# RP-1515 Perceived air quality

Very satisfied 👍  Very dissatisfied 👎

"How satisfied are you with the air quality in your workplace right now ? "

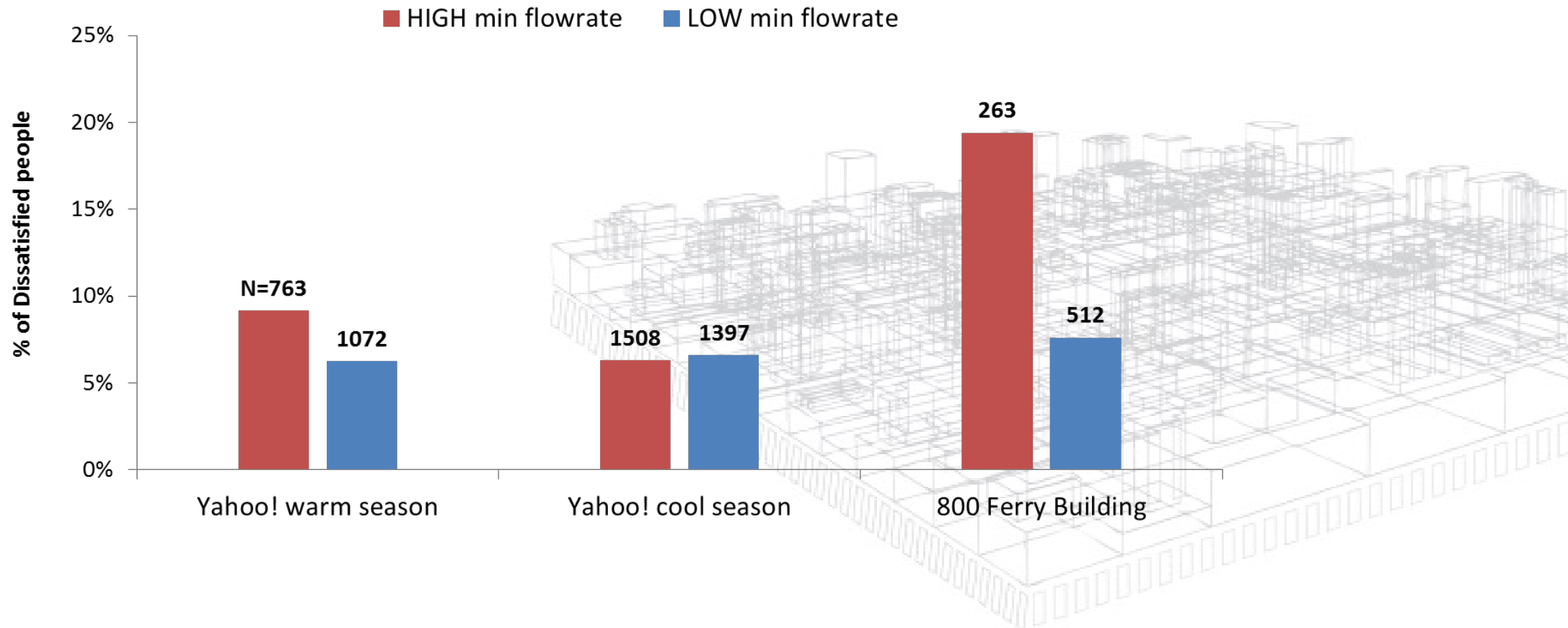

# RP-1515 CBE survey results

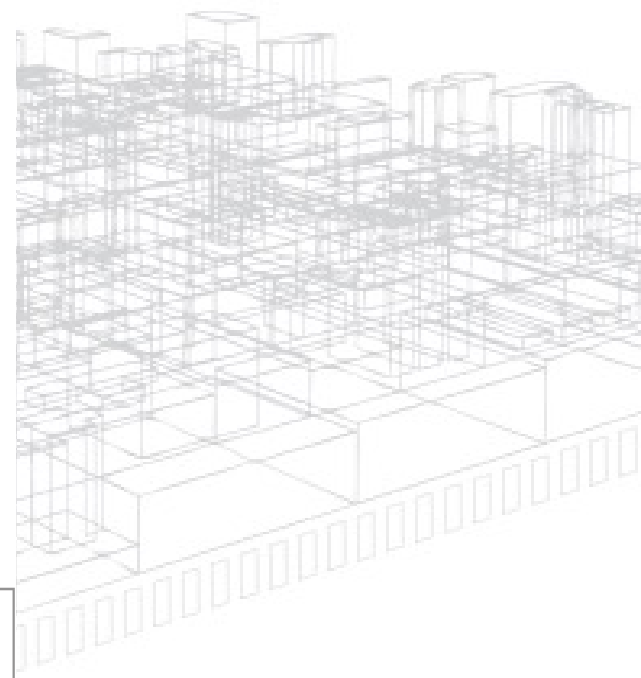

# RP-1515 Lab Tests

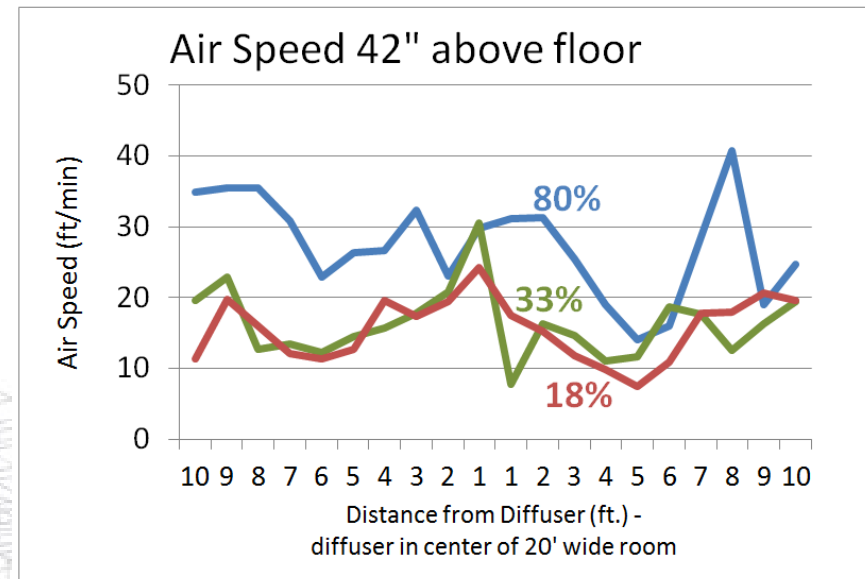
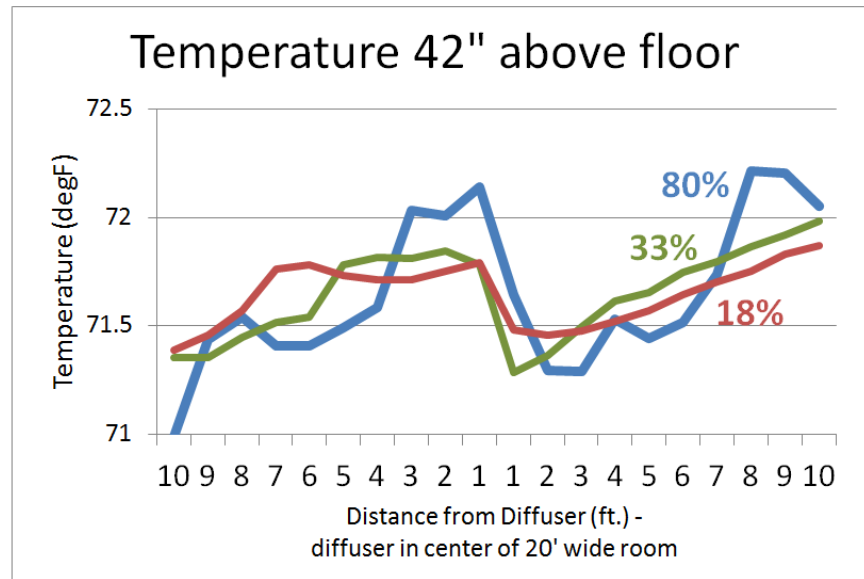

Perforated diffusers with blades in the neck, Cooling Mode.

## Results:

- Negligible impact on ADPI – all near 1
- Negligible impact on ACE – all near 1



# Dual Maximum VAV Logic

- Advantages
  - Lower fan energy
  - Lower heating energy: avoids high minimums which can drive zone into heating
  - Lower reheat energy
  - Control of supply air temperature reduces stratification
  - Better modulation of HW valve and less SAT overshoot
  - HW circuit is self-balancing with 2-way valves
  - Improved comfort
  - Complies with Standard 90.1!
- Disadvantages
  - Requires discharge air temperature sensor

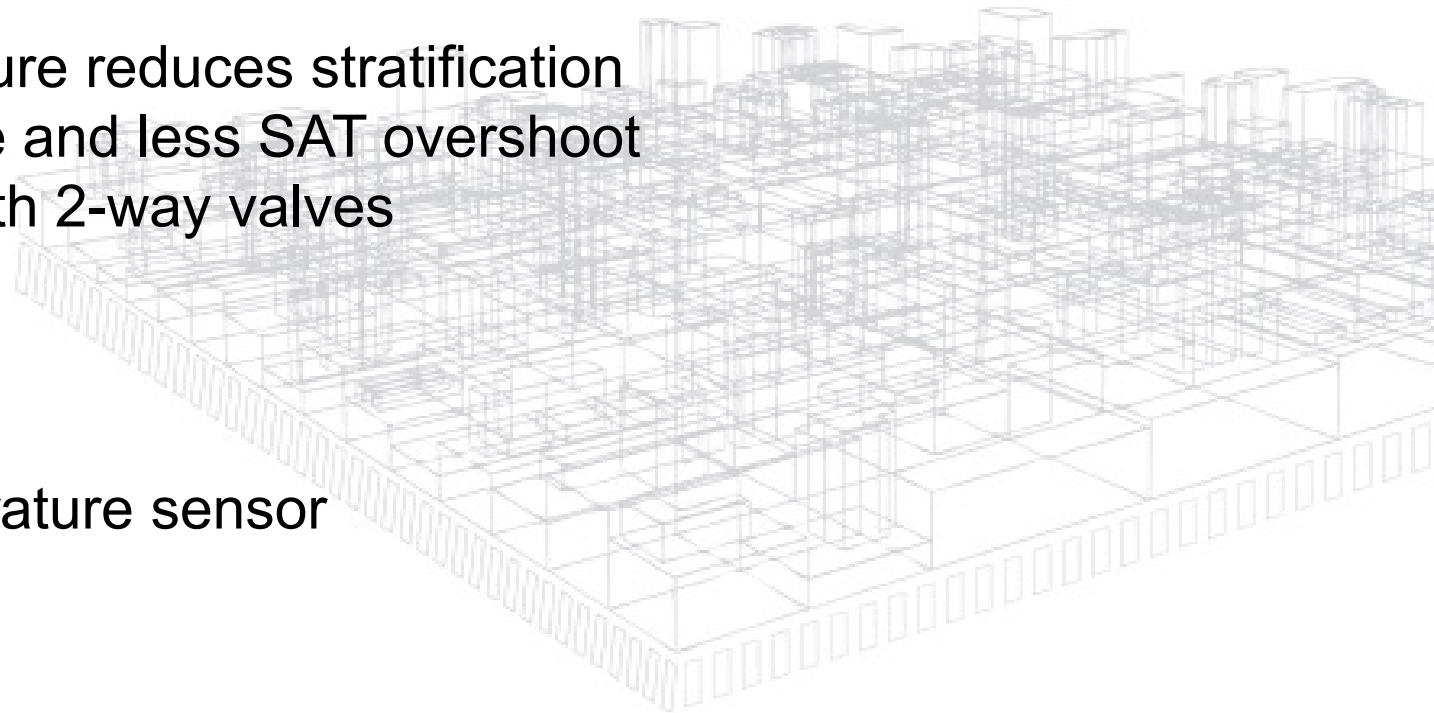

# Example: Static Pressure Setpoint Reset using Trim & Respond

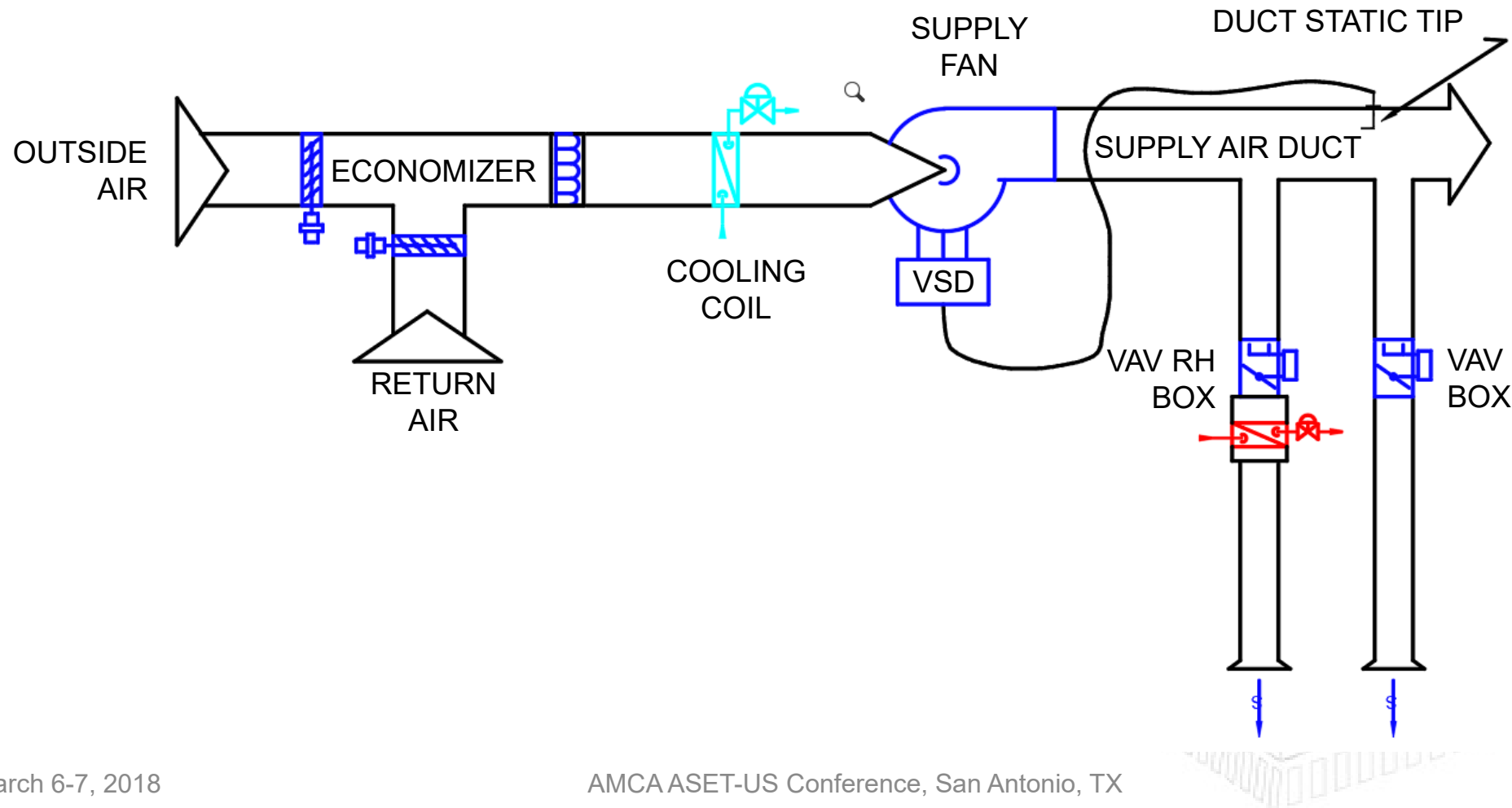

# Trim & Respond Setpoint Reset

- Used to reset setpoints based on zone demand, e.g.
  - Static pressure
  - Supply air temperature
  - HW and CHW supply temperature
- Zones issue “requests” based on zone temperature loops or damper/valve position
  - E.g. “Generate 1 request when damper position exceeds 95%”
  - Extra requests can also be generated based on error from setpoint
- Multiply “requests” by zone Importance Multiplier
  - IM=0 means ignore the zone
  - IM=1 default
  - IM>1 for critical zones to get past “Ignores”
- Send to AHU controller to adjust setpoint
  - Every time-cycle setpoint is reduced (“trim”)
  - But setpoint is increased (“respond”) proportional to number of zone “requests” (up to a maximum change)

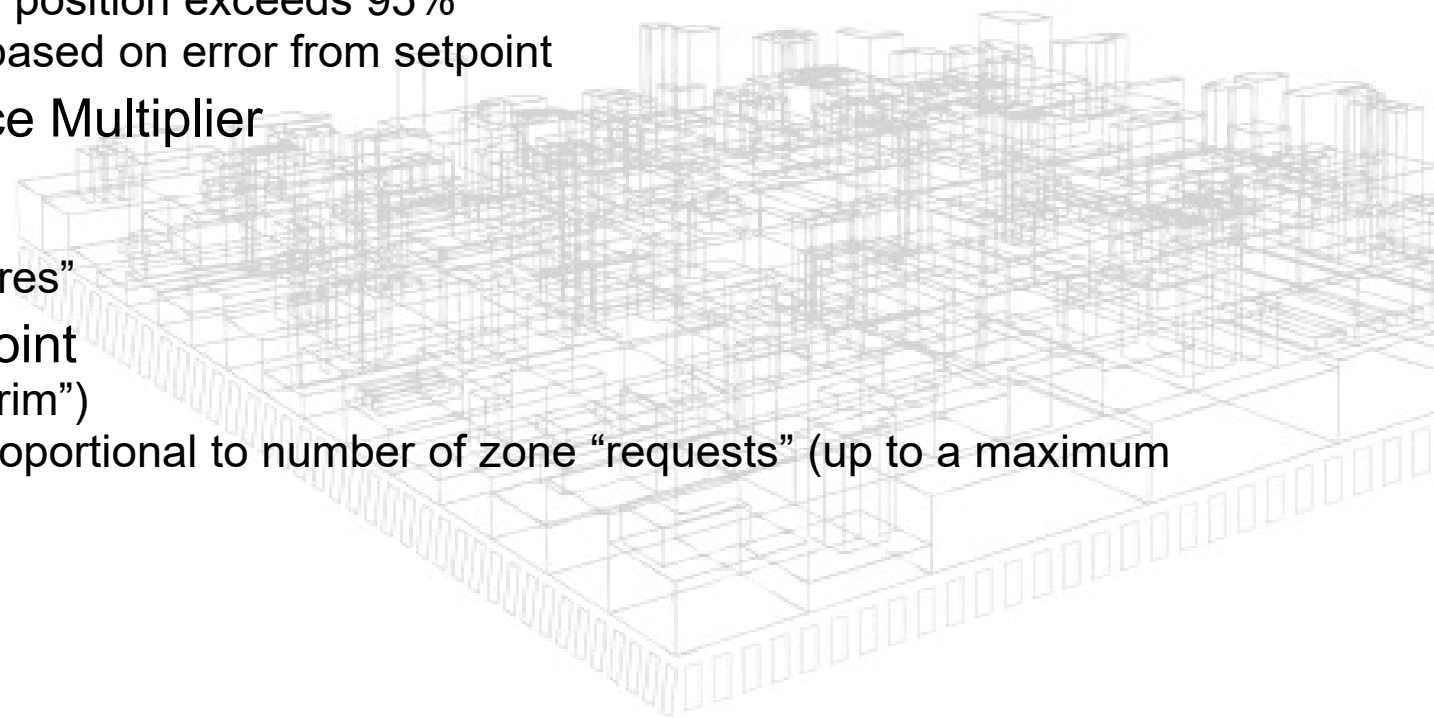

# Trim & Respond Example

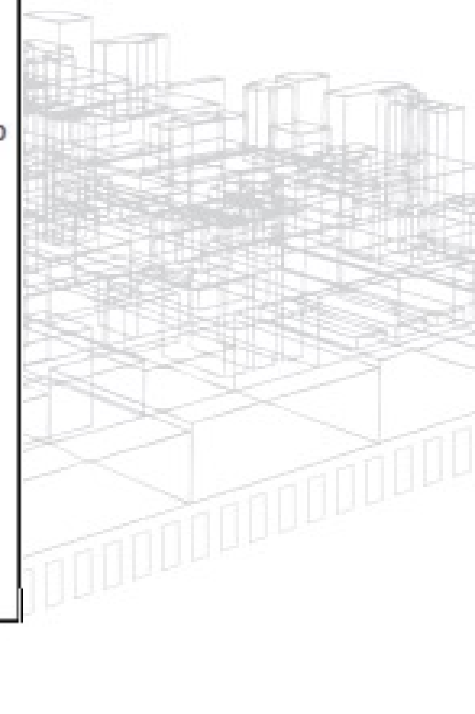
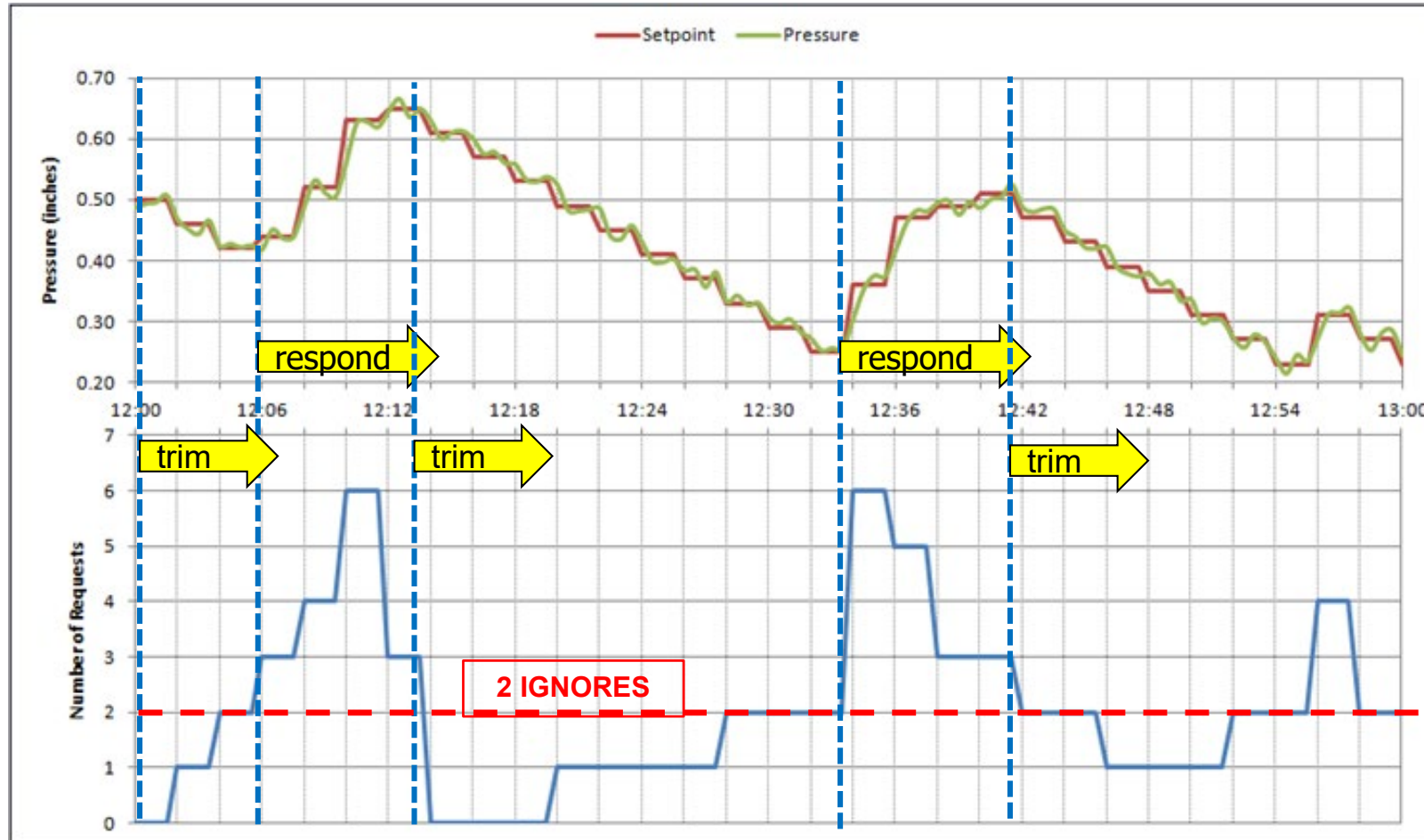

# Reset Trend Data (TAB SP=1.25")

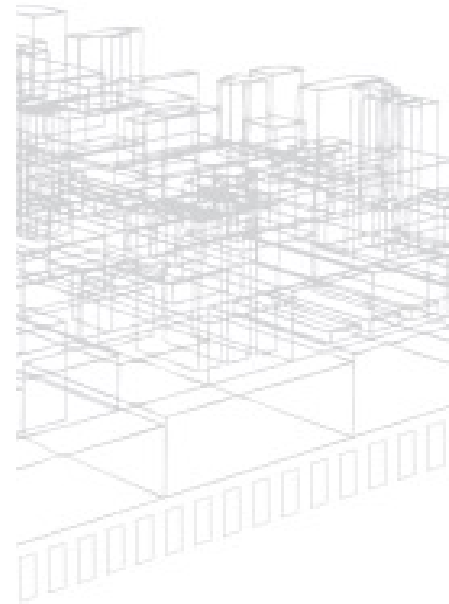
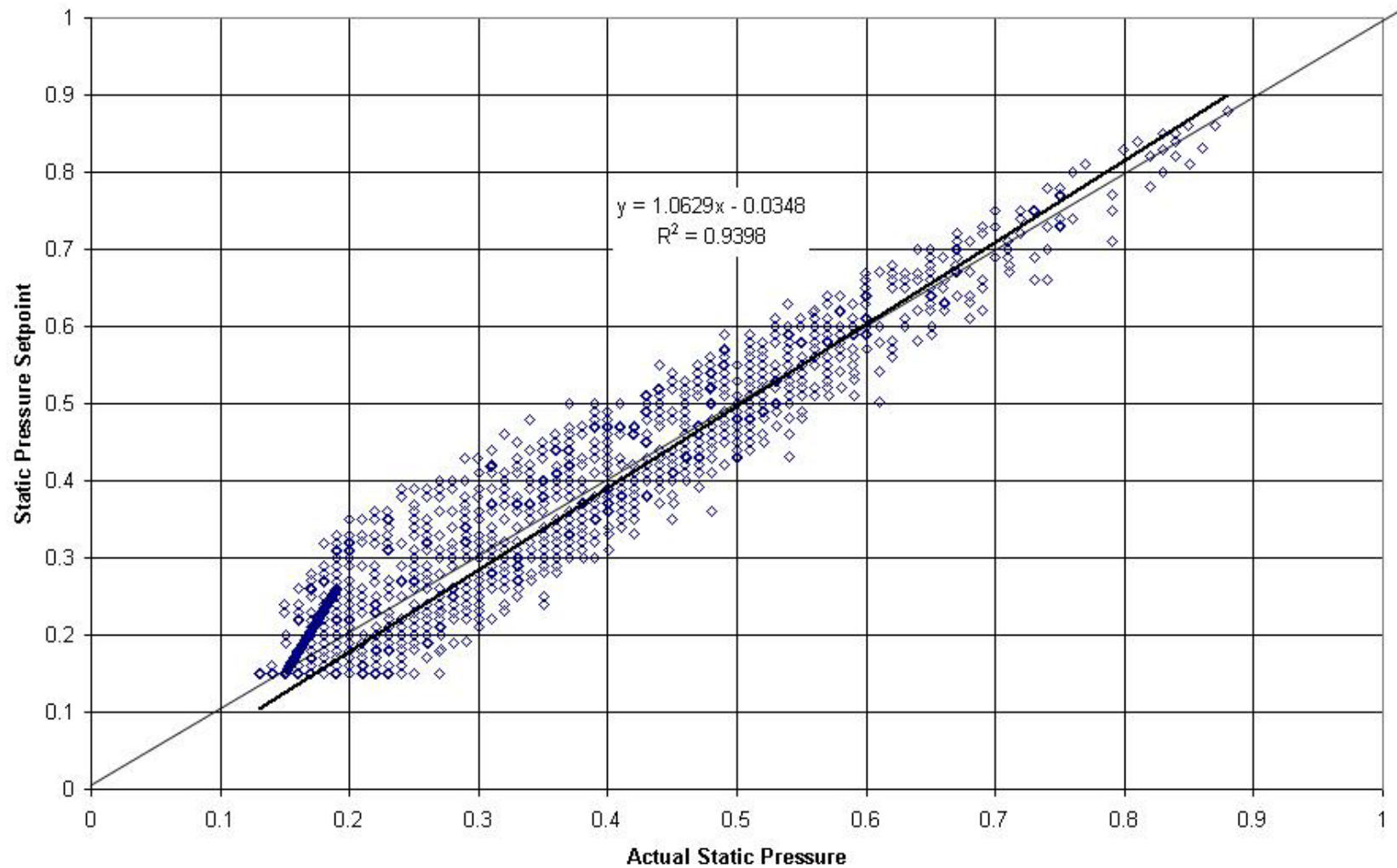

# Fan Energy at Varying SP Setpoints

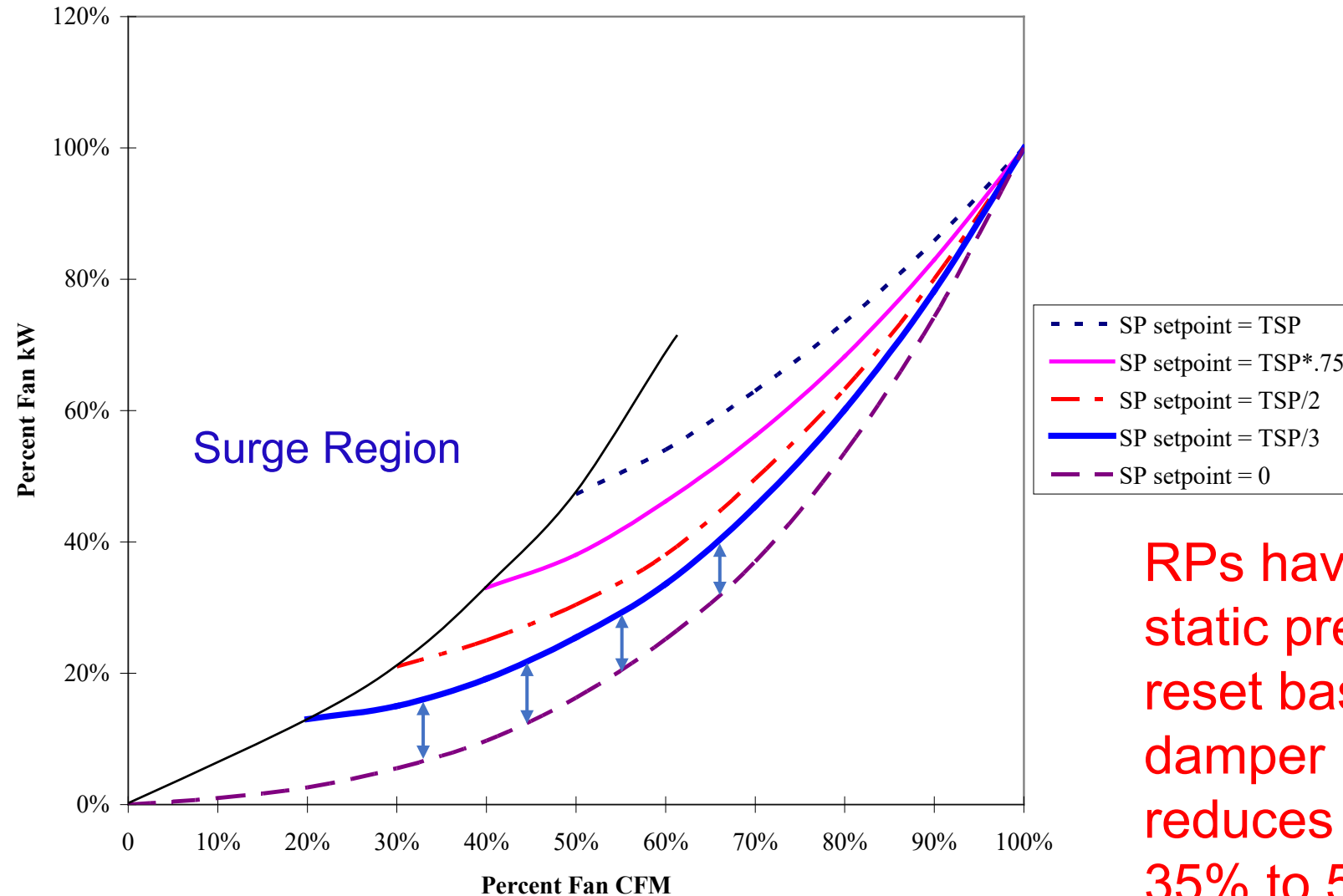

RP's have shown static pressure SP reset based on damper position reduces fan energy 35% to 50%

# Rogue Zones

- A rogue zone is one that is always requesting more (more static pressure, colder CHW, or hotter HHW)
  - Example causes
    - Load larger than anticipated in design
    - Poor duct design/construction
    - Extreme setpoint adjustments
    - Equipment failure (broken damper, valve)
- This drives the reset loop to extremes and prevents energy savings.
- Once identified (discussed later), rogue zones can be
  - Repaired
  - Locked out of the T&R control loop if non-critical
    - “Importance Multiplier” set to 0

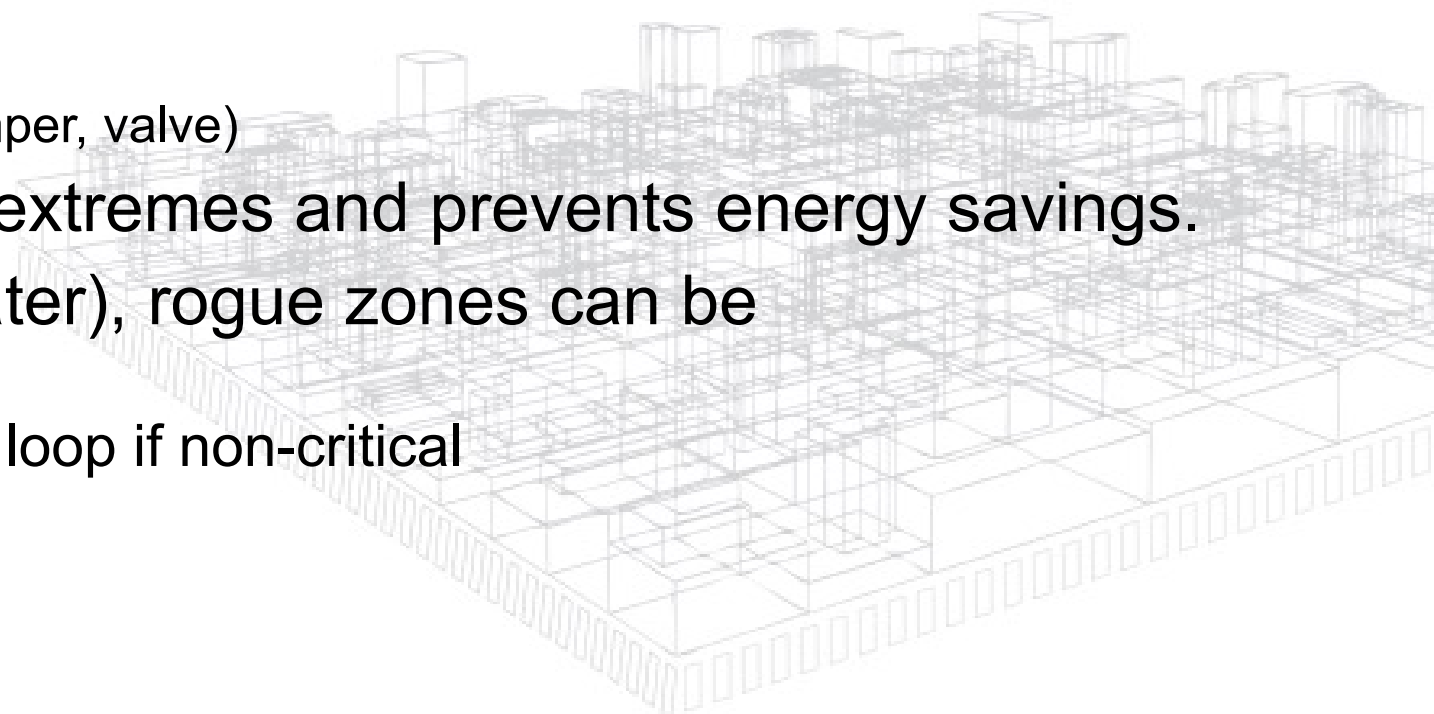





# Detecting Rogue Zones

- BAS calculates Request-Hours for each zone, and alarms on high cumulative %-Request-Hours.
  - b) Request-Hours. Provided SystemOK is true, every x minutes (default 5 minutes), add  $x/60$  times the current number of Requests to this request-hours accumulator point. The request-hours point is reset to zero upon a global command from the system/plant serving the zone/system – this global point simultaneously resets the request-hours point for all zones/systems served by this system/plant.
  - c) Cumulative%-Request-Hours. This is the zone/system Request Hours divided by the zone/system run-hours (the hours in any Mode other than Unoccupied Mode) since the last reset, expressed as a percentage.
  - d) A Level 4 alarm is generated if the zone Importance Multiplier is greater than zero, the zone/system Cumulative% Request Hours exceeds 70%, and the total number of zone/system run hours exceeds 40.
- Decision to set IM=0 for rogue zones up to operator (not automatic)

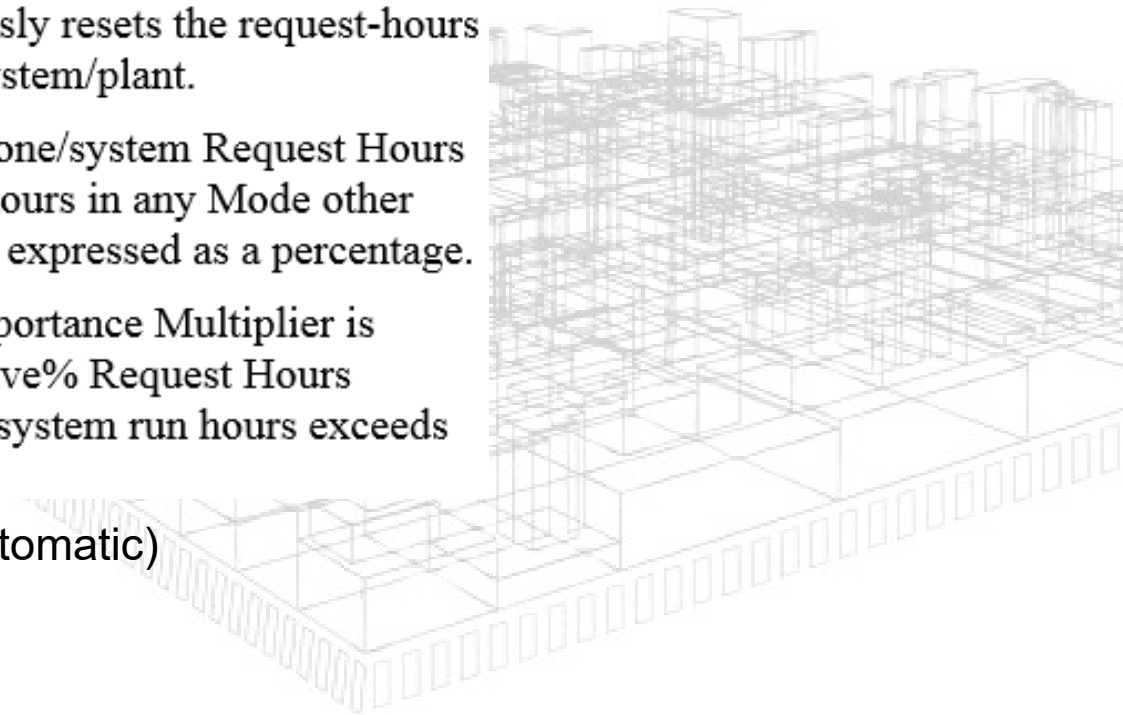

# T&R Rogue Zones

## VAV Box Table Graphic

Zone ID	Operating Mode	Airflow (CFM)	Airflow SP (CFM)	Zone Temp (°F)	Htg SP (°F)	Clg SP (°F)	Damper Pos (% Open)	HW Valve Pos (%Open)	DA Temp (°F)	DA Temp SP (°F)	CO2 Level (PPM)	Static Pressure Reset		
												Requests	Cumulative Req Hrs (%-req-hrs)	Importance Multiplier
VR-19-1	Deadband	342	330	73.3	71.0	74.0	29	0%	56.9	55.0	na	0	10%	1
VR-19-2	Cooling	278	280	73.9	71.0	74.0	31	0%	57.2	55.0	na	0	2%	1
VR-19-3	Cooling	275	279	73.1	70.0	73.0	24	0%	57.2	55.0	na	0	1%	1
VR-19-4	Deadband	245	235	72.9	71.0	74.0	16	0%	57.2	55.0	565	0	6%	1
VR-19-5	Deadband	184	180	72.3	71.0	74.0	25	0%	58.7	55.0	na	0	3%	1
VR-19-6	Cooling	1147	1144	70.8	68.0	71.0	45	0%	57.2	55.0	na	0	6%	1
VR-19-7	Deadband	102	100	73.0	71.0	74.0	32	0%	59.1	55.0	na	0	1%	1
VR-19-8	Deadband	252	250	72.9	71.0	74.0	41	0%	57.5	55.0	na	0	6%	1
VR-19-9	Deadband	508	500	73.1	72.0	75.0	15	0%	58.4	55.0	na	0	1%	1
VR-19-10	Deadband	308	300	72.4	71.0	74.0	31	0%	57.2	55.0	na	0	9%	1
VR-19-11	Deadband	290	270	73.5	71.0	74.0	32	0%	58.1	55.0	na	0	1%	1
VR-19-12	Deadband	368	360	74.3	72.0	75.0	11	0%	57.1	55.0	na	0	3%	1
VR-19-13	Deadband	512	500	73.7	71.0	74.0	32	0%	58.6	55.0	505	0	14%	1
VR-19-14	Cooling	673	675	73.8	71.0	74.0	54	0%	56.0	55.0	na	0	35%	1

Importance Multiplier

%-Request-Hours



# Example: Zone Groups (aka “Isolation Areas”)

- Zone Group
  - Groups of 1 or more VAV zones
  - Each Zone Group has its own operating schedules and System Modes (Occupied Mode, Warmup Mode, etc.)
  - AHU minimum ventilation rate based only on Occupied Zones
  - AHU operates in “highest” priority mode of Zone Groups served
- Required by Standard 90.1 and CA Title 24 since 1997, but almost always overlooked:

6.4.3.3.4 *HVAC systems* serving zones that are intended to operate or be occupied nonsimultaneously shall be divided into isolation areas. Zones may be grouped into a single isolation area provided it does **not exceed 25,000 ft<sup>2</sup> of conditioned floor area nor include more than one floor.** Each isolation area shall be equipped with *isolation devices* capable of and configured to automatically shut off the supply of conditioned air and *outdoor air* to and exhaust air from the area. Each isolation area shall be controlled independently by a device meeting the requirements of Section 6.4.3.3.1.

# **Tip#2: Set VAV Box minimum setpoint to minimum ventilation rate**



# Tip#2: Set VAV Box minimum setpoint to minimum ventilation rate

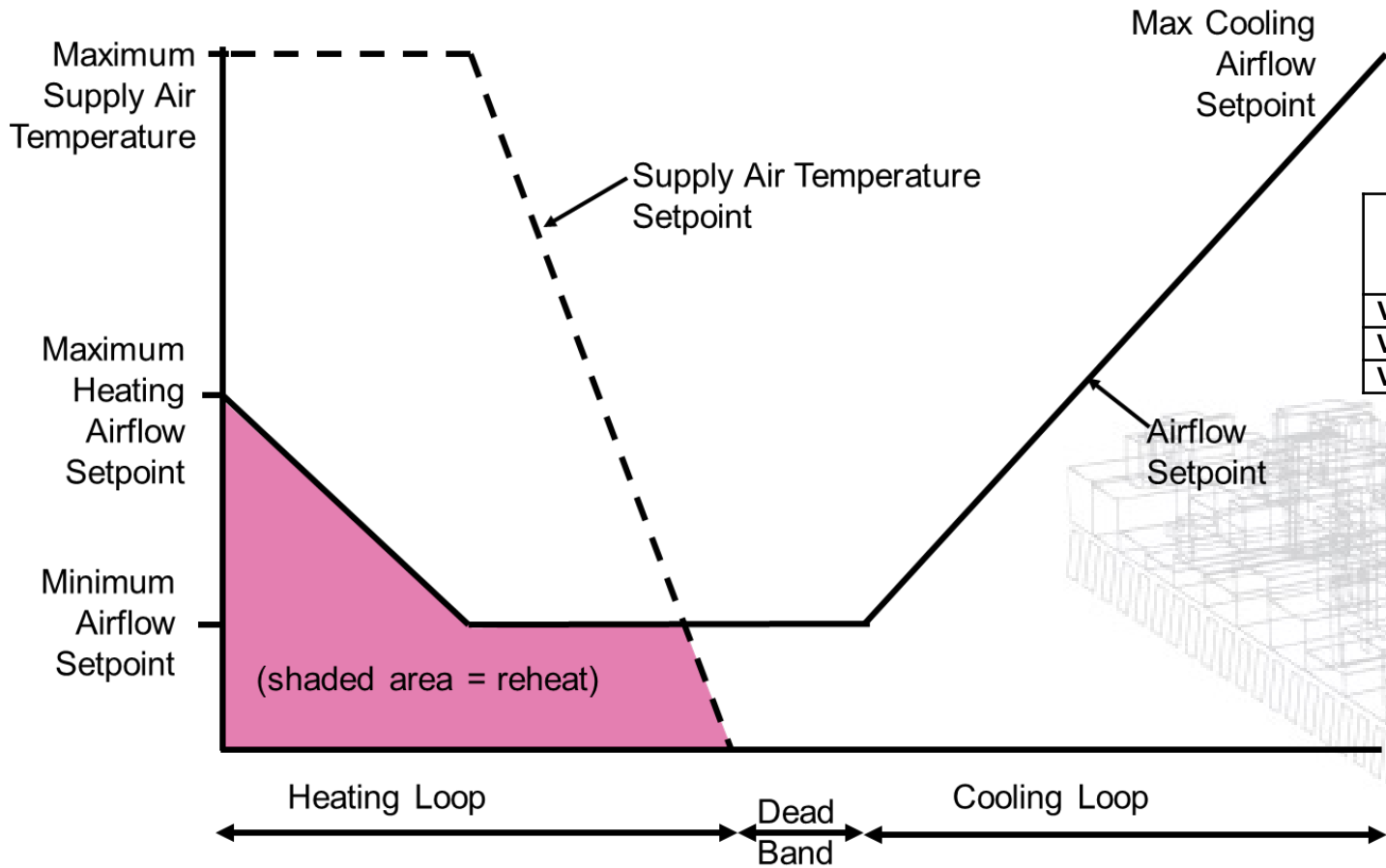

TAG	INLET SIZE	DESIGN CFM			MIN OA CFM		CO2 CONTROL
		COOL	MIN	HEAT	AREA	PEOP	
VR-101	10	755	50	300	50	210	Y
VR-102	10	700	50	350	50	210	Y
VR-103	12	950	105	290	70	105	N

Minimum Ventilation Rate

# Supposed Issues

- Minimum controllable setpoint is much higher according to VAV box manufacturers
- What about Standard 62.1 and complying with the Multiple Spaces Equation?

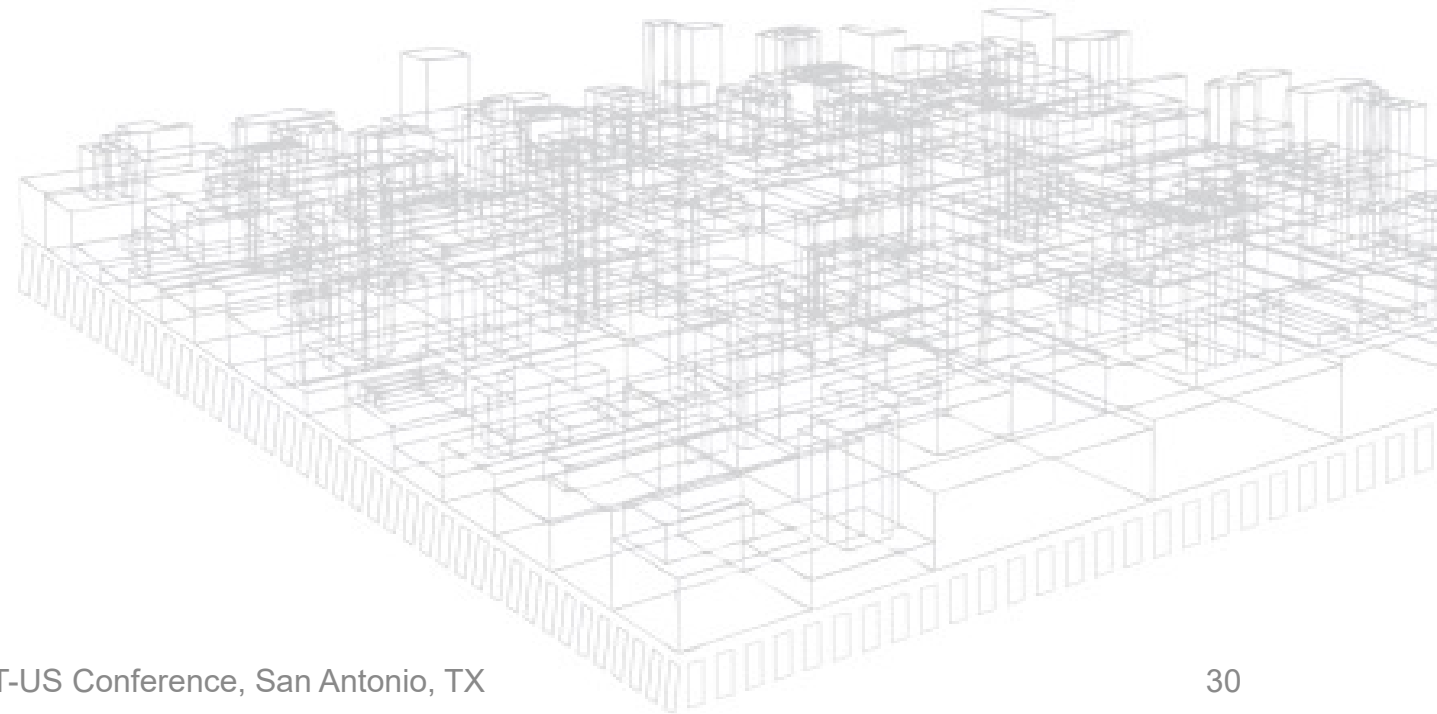

# What is the lowest minimum?

- Function of
  - DDC Controller: What's the lowest controllable velocity pressure (VP) signal?
    - DDC velocity pressure transducer accuracy
    - A/D converter resolution (bits)
  - VAV Box:
    - Amplification factor, F
    - Inlet size, D
- Calculated in Guideline 36 by controls contractor

$$FPM_{\min} = 4005 \sqrt{\frac{VP_{\min}}{F}} \quad CFM_{\min} = FPM_{\min} \left( \frac{\pi D^2}{4} \right)$$

# Why Not Just Look in the VAV Box Catalog?

Inlet Size	Total CFM Range	CFM Ranges of Minimum and Maximum Settings							
		PESV - Pneumatic Controller		PESV - Pneumatic Controller		AESV - Analog Electronic TA1 Controller		DESV - Digital Electronic TD1 Controller	
		Minimum	Maximum	Minimum	Maximum	Minimum	Maximum	Minimum	Maximum
4	0-225	45*-170	80-225	55*-170	80-225	45*-225	45-225	45*-225	45-225
5	0-350	65*-270	120-350	85*-270	120-350	65*-350	65-350	65*-350	65-350
6	0-500	80*-330	150-500	105*-330	150-500	80*-500	80-500	80*-500	80-500
7	0-650	105*-425	190-650	135*-425	190-650	105*-650	105-650	105*-650	105-650
8	0-900	145*-590	265-900	190*-590	265-900	145*-900	145-900	145*-900	145-900
9	0-1050	175*-700	315-1050	225*-700	315-1050	175*-1050	175-1050	175*-1050	175-1050
10	0-1400	230*-925	415-1400	300*-925	415-1400	230*-1400	230-1400	230*-1400	230-1400
12	0-2000	325*-1330	600-2000	425*-1330	600-2000	325*-2000	325-2000	325*-2000	325-2000
14	0-3000	450*-1800	810-3000	575*-1800	810-3000	450*-3000	450-3000	450*-3000	450-3000
16	0-4000	580*-2350	1100-4000	750*-2350	1100-4000	580*-4000	580-4000	580*-4000	580-4000
24x16	0-8000	1400*-5200	2600-8000	1800*-5200	2600-8000	1400*-7500	1400-7500	1400*-7500	1400-7500

\* Factory CFM settings (except zero) will not be made below this range because control accuracy is reduced. On pressure dependent units, minimum CFM is always zero and there is no maximum.

Equates to ~0.03" minimum VP and about 30% of design CFM for typical box selections. Way too conservative!

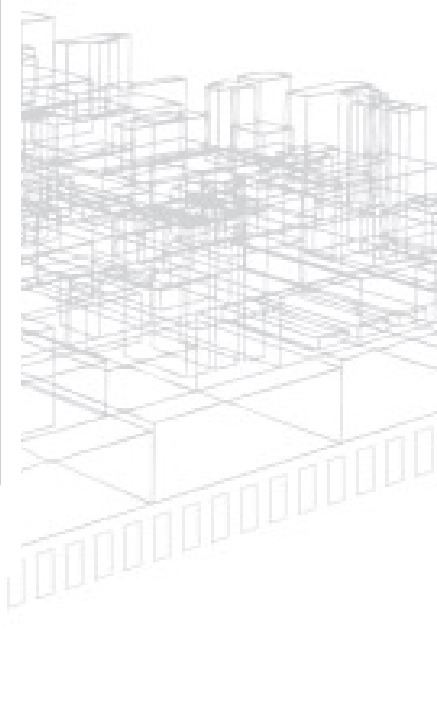



# Why Not Just Look in the VAV Box Catalog?

Still too high

UNIT SIZE	400 SERIES (PNEUMATIC) STANDARD CONTROLLER		7000 SERIES ANALOG ELECTRONIC		DDC CONSIGNMENT CONTROLS (See Notes Below)				
	MIN.	MAX.	MIN.	MAX.	MIN.			MAX.	
					Min. transducer differential pressure (in. w.g.)			Max. transducer differential pressure (in. w.g.)	
					0.015	0.03	0.05	1.0	≥1.5
4	43	250	35	250	30	43	55	250	250
5	68	350	50	350	48	65	88	350	350
6	75	490	60	550	53	75	97	435	530
8	145	960	115	1000	105	145	190	840	1000
10	235	1545	185	1600	165	235	305	1355	1600
12	340	2250	285	2300	240	340	440	1975	2300
14	475	3100	390	3100	335	475	615	2750	3100
16	625	4100	520	4100	440	625	805	3595	4100
19	1180	6500	1025	6500	845	1180	1510	6375	6500
22	1730	8000	1450	8000	1260	1730	2200	8000	8000

## NOTES:

1. Minimum and maximum airflow limits are dependent on the specific DDC controller supplied. Contact the control vendor to obtain the minimum and maximum differential pressure limits (inches W.G.) of the transducer utilized with the DDC controller.
2. Maximum CFM is limited to value shown in General Selection Data.

Good Advice! NEVER use Box manufacturer's minimums!

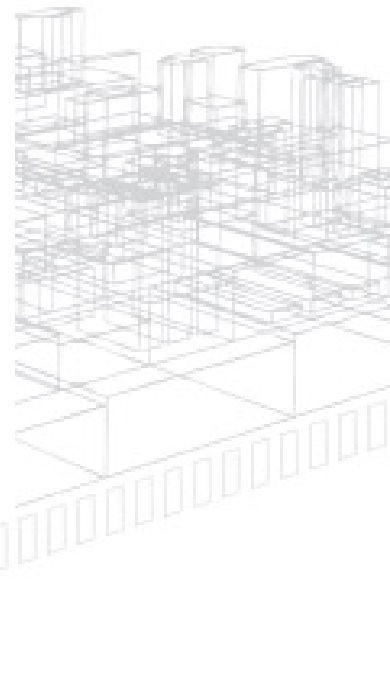

# Controllable VP Minimum

- Some manufacturers list the range in catalog

## Velocity Pressure Input

Control Range 0.004 to 1.5 in. of W.C.

Over Pressure Withstand  $\pm 20$  in. of W.C.

Accuracy  $\pm 5\%$  at 1.00 in. of W.C. with laminar flow at 77 °F (25 °C) and suitable flow station.

Sensor Type Self-calibrating flow sensor (differential pressure).

- Some you have to ask
- Most are available from ASHRAE RP 1353 and PG&E research projects (see references)
  - Almost all controllers  $\pm 10\%$  at 0.003"
- Don't worry about – just specify allowable setpoint  $\leq 0.004$ "!

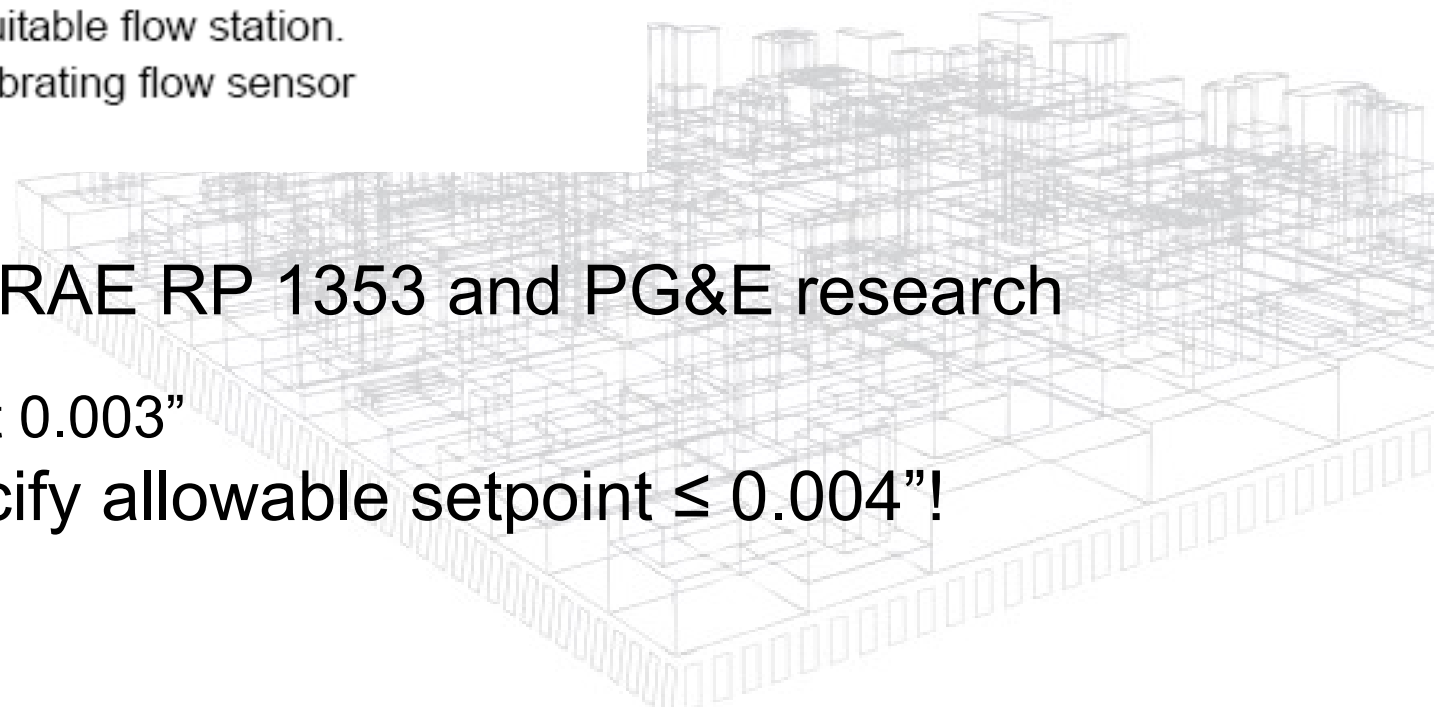

# Typical DDC Performance

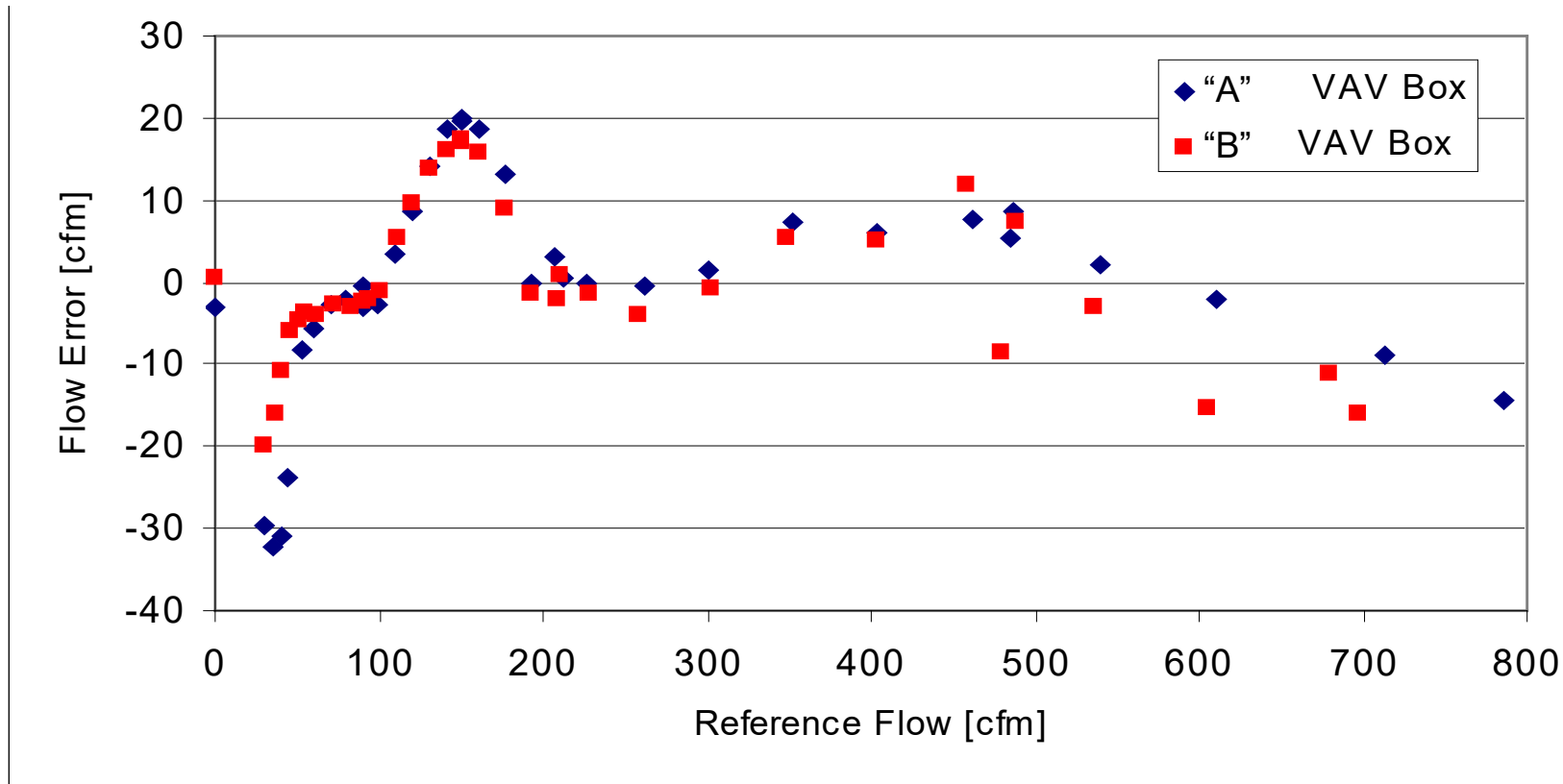

Highly accurate down to about 50 CFM (0.003")

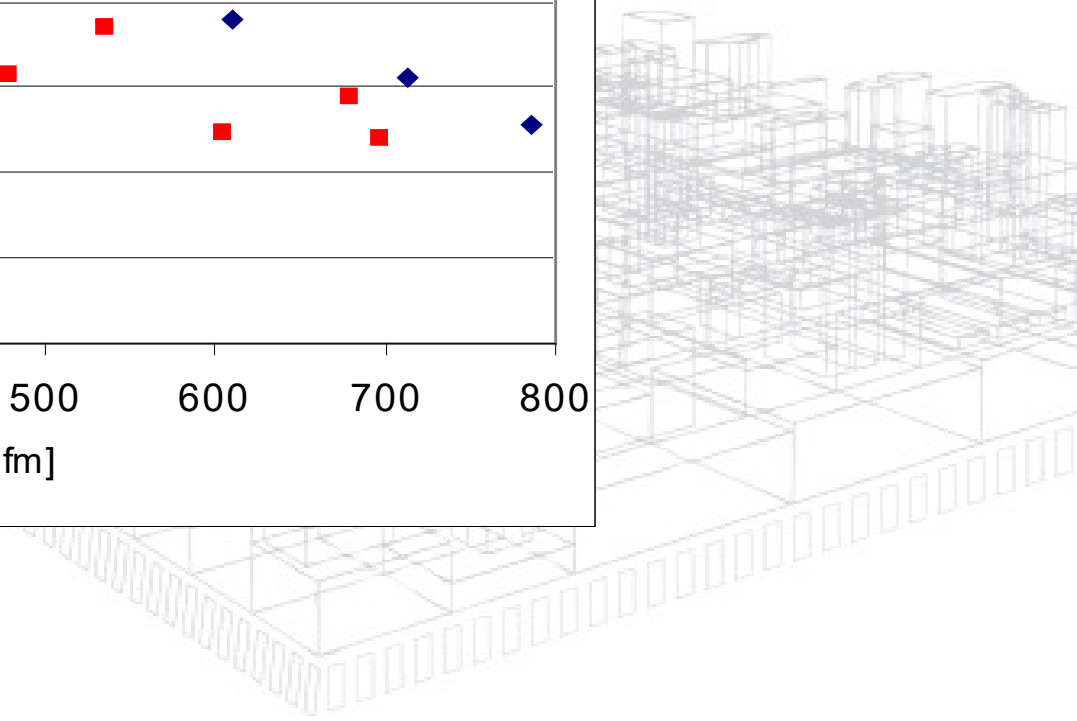

# Flow Probe Amplification

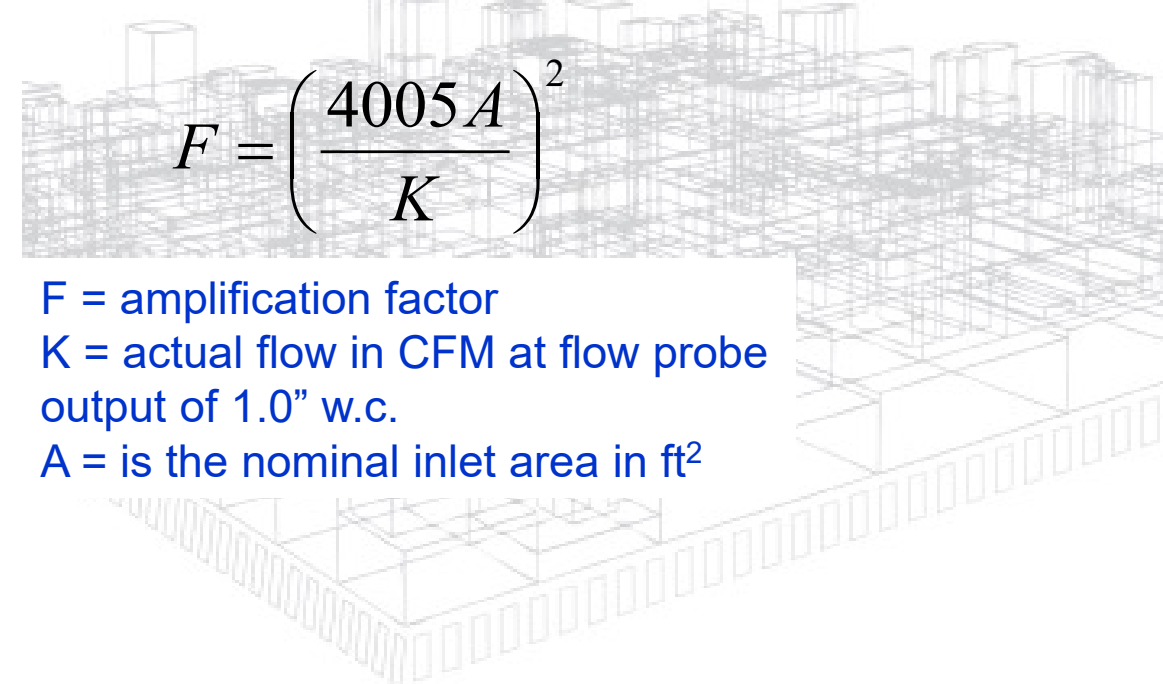
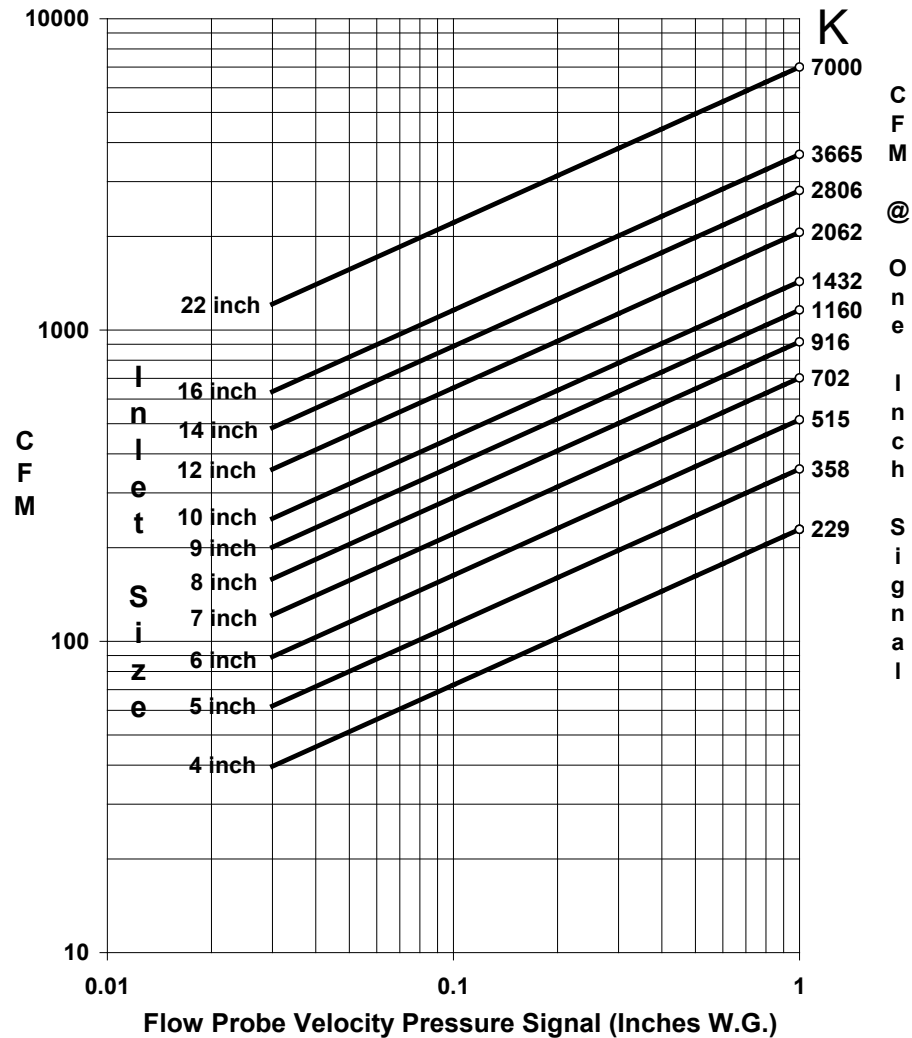

$$F = \left( \frac{4005 A}{K} \right)^2$$

**F** = amplification factor  
**K** = actual flow in CFM at flow probe output of 1.0" w.c.  
**A** = is the nominal inlet area in ft<sup>2</sup>

# Typical Flow Probe Performance

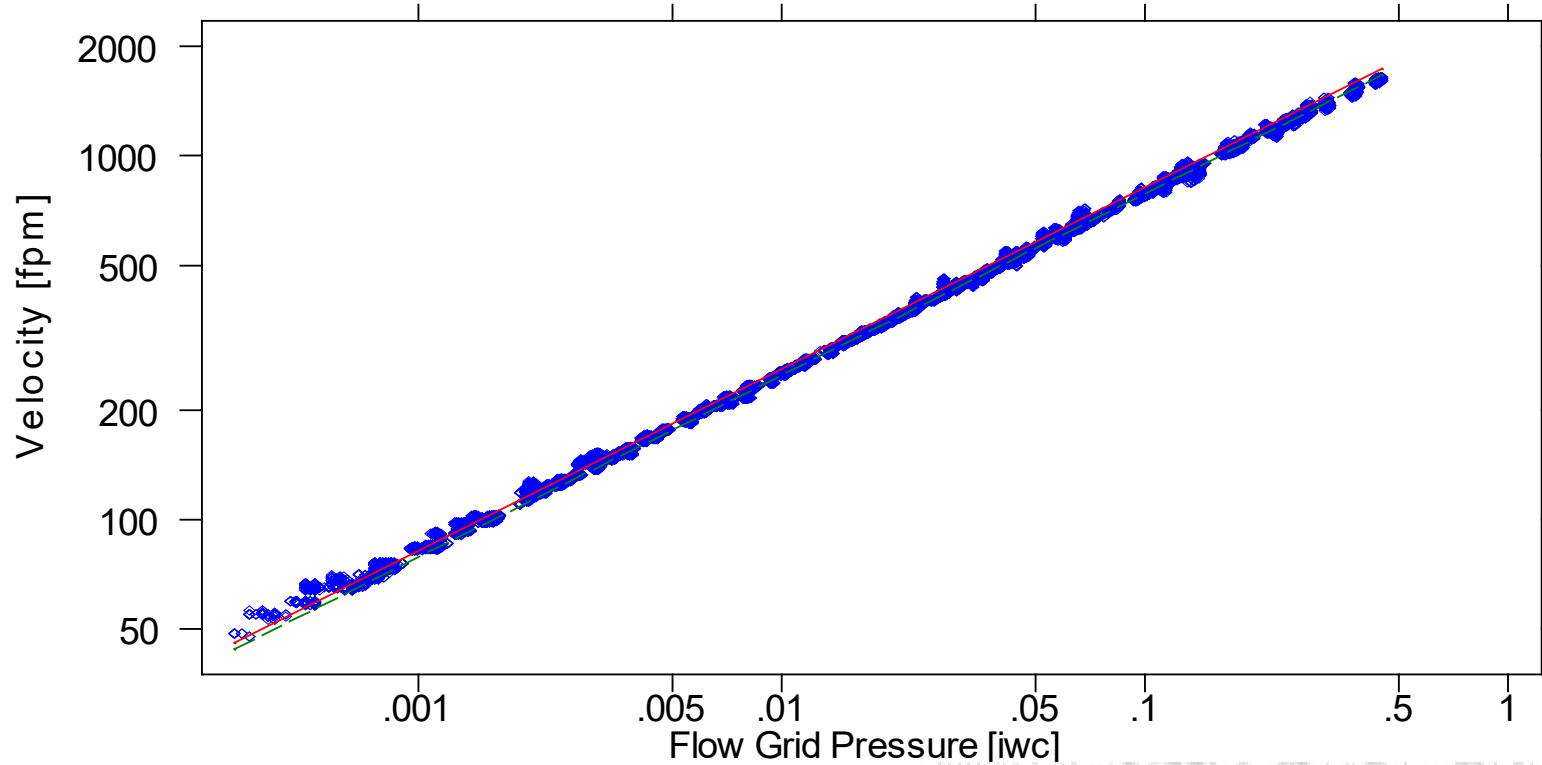

$$F = slope \sim 2.6$$

Specify  $\geq 2.0$

# Sample Controllable Minimum

$$FPM_{\min} = 4005 \sqrt{\frac{VP_{\min}}{F}} \qquad 170 = 4005 \sqrt{\frac{0.004}{2.3}}$$

$$CFM_{\min} = FPM_{\min} \left( \frac{\pi D^2}{4} \right)$$

Box Inlet Diameter	Maximum CFM at 0.5 in.w.g. pressure drop	Minimum CFM at 0.004 in.w.g. sensor reading	Minimum Ratio at Highest Maximum, %	Minimum Ratio at lowest Maximum, %
6	425	33	7.8%	-
8	715	58	8.1%	13.6%
10	1,100	91	8.3%	12.7%
12	1,560	130	8.3%	11.8%
14	2,130	177	8.3%	11.3%
16	2,730	232	8.5%	10.9%

# What about Standard 62.1 Multiple Spaces compliance?

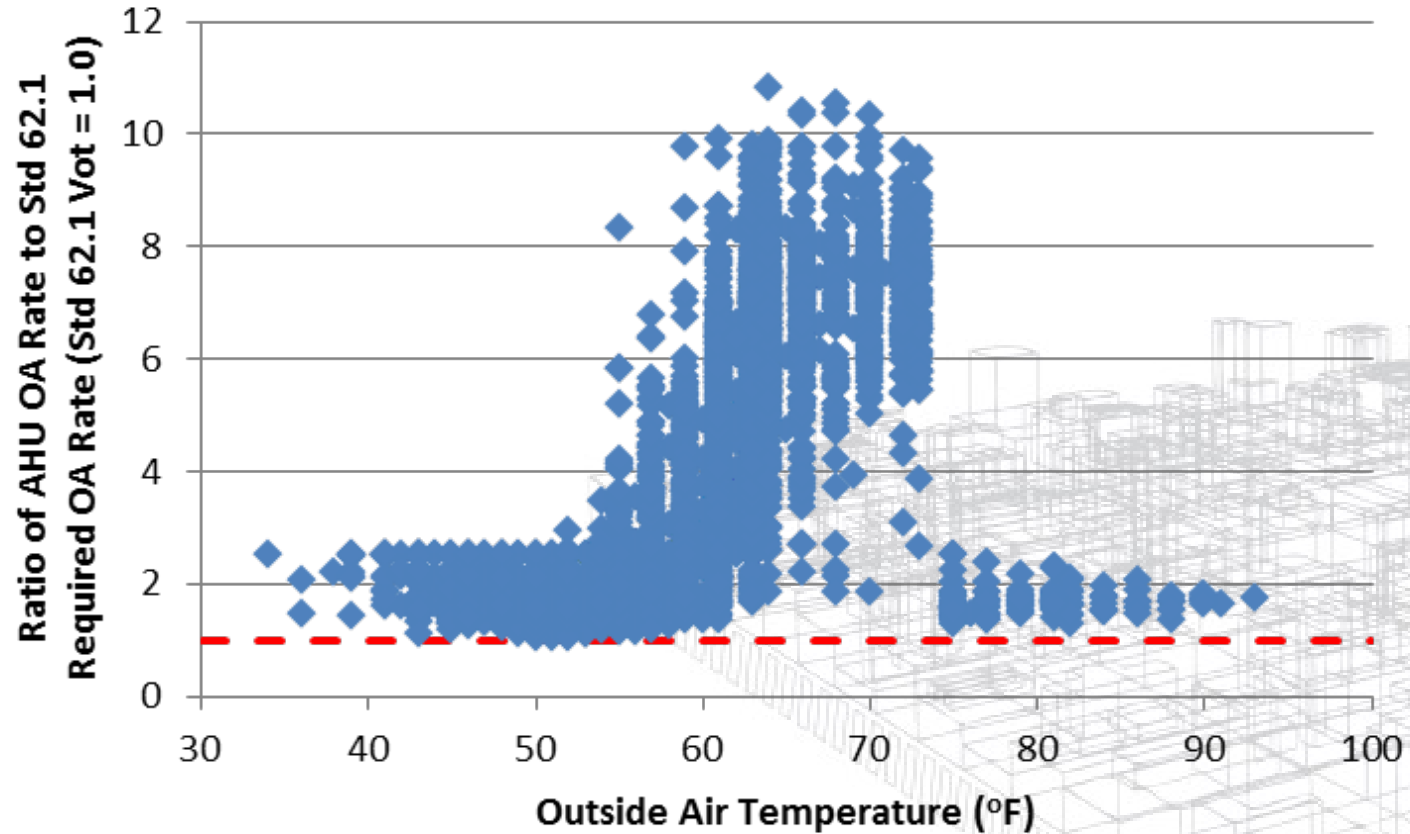

Oakland Office - VAV System with Outdoor Air Economizer,  
VAV Box Minimum = Title 24 outdoor air minimum

# Recent Standard 62.1 Updates

- Addendum f to Standard 62.1-2016

$$V_{pz-min} = V_{oz} * 1.5$$

Space Type	cfm/ft <sup>2</sup> w/o DCV	cfm/ft <sup>2</sup> with DCV
Office	0.13	0.09
Conference room	0.47	0.09
Classroom	0.71	0.18

- Even better: RP-1547 and 1747
  - For systems with CO2 or occupancy sensors in almost every zone
  - All zone minimums determined dynamically by controls – not by designer – to minimize efficiency while ensuring 62.1 compliance
  - Multiple Spaces Equation solved dynamically by the AHU controls
  - Will be added to Guideline 36 in next year



# Time-Averaged Ventilation (TAV)

- What happens if ventilation minimum is less than controllable minimum?
- Standard 62.1 allows time averaging over the room time constant (typical 1 to 6 hours)
- TAV pulses the minimum from zero to the controllable minimum every 1.5 minutes and ensures average minimum is maintained over a 15 minute window
- This is already included in Guideline 36

# Tip#2: Set VAV Box minimum setpoint to minimum ventilation rate

- Designers need not consider controllable minimum
  - VAV manufacturer data is usually wrong and can be ignored
  - Per Guideline 36, minimum is determined by the BAS contractor based on their controller's capability and VAV box flow probe amplification factor
  - Do specify BAS VAV controller minimum  $VP \leq 0.004$ "
  - Do specify VAV flow probe amplification factor  $F \geq 2$
- Simply set box minimum to Standard 62.1 Addendum f value
  - If the controllable minimum is higher, a Guideline 36 compliant controller will use TAV

# Tip#3 Use Fan Arrays

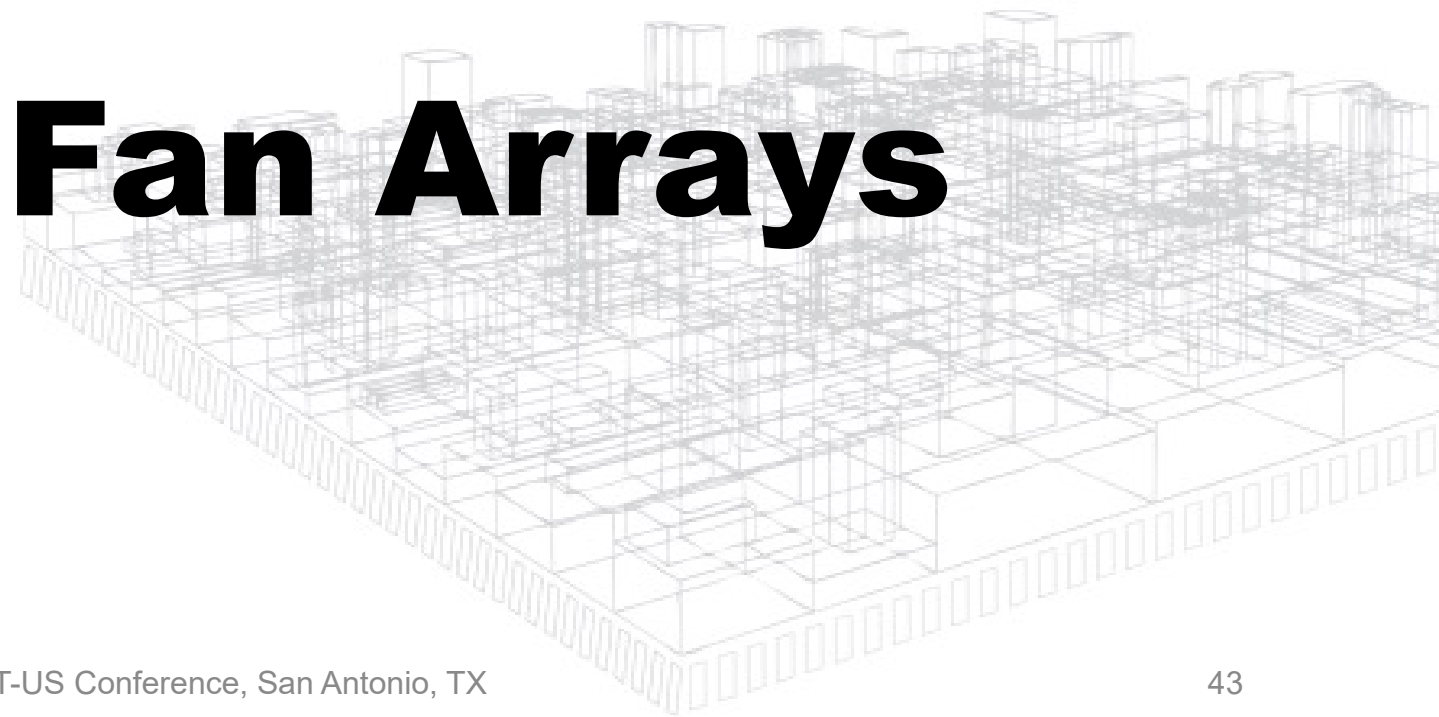

# Fan Arrays

Array of small single-width, single inlet direct-drive plenum fans



# Advantages of Fan Arrays

- Reduced AHU length
- Reduced sound power, especially on the discharge side
- Improved redundancy
  - Better still if multiple VFDs or ECMs are provided
- Reduced fan energy if sound attenuators or system effect are eliminated
- Usually same or lower net overall installed costs
- Easier motor and fan replacement
- Easier to install in retrofit applications

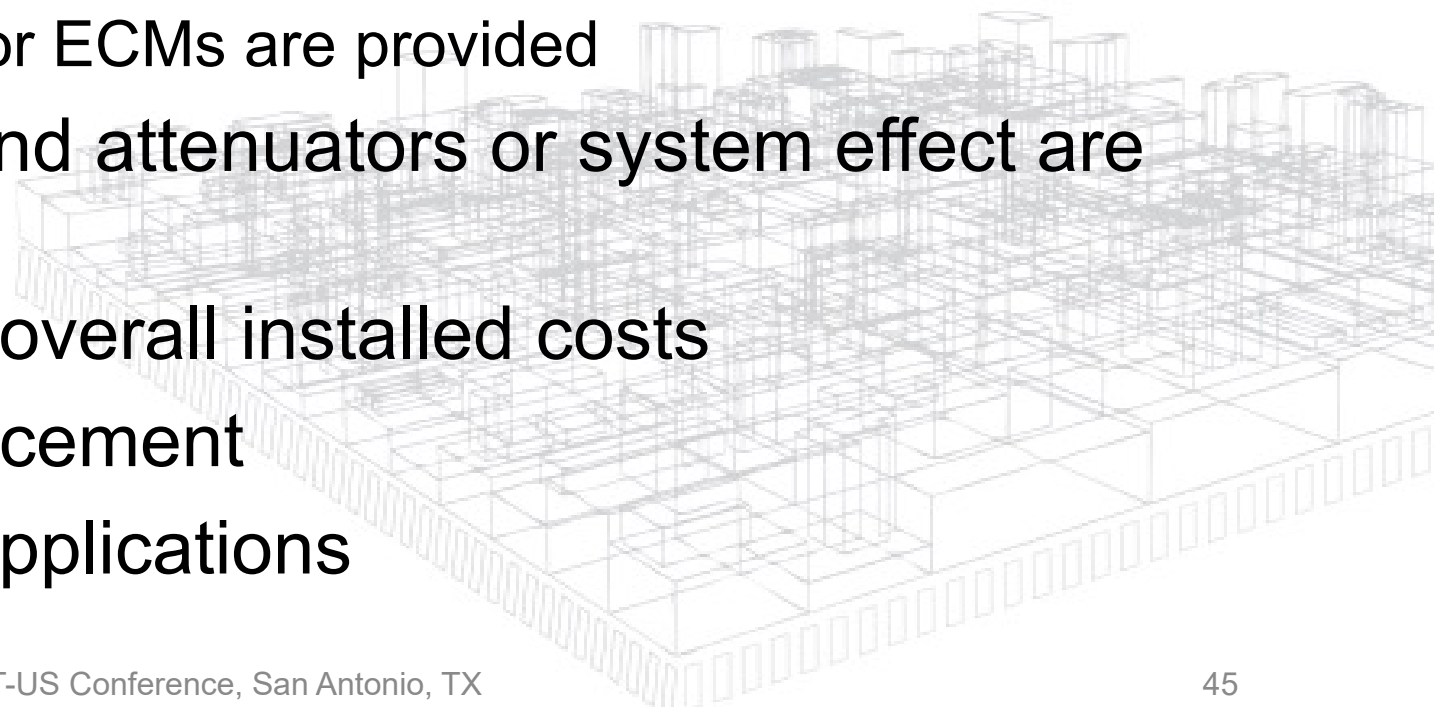

# Large Fan Array Fan/VSD Staging

Requires:

- Multiple VSDs or ECMs
- Backdraft dampers

Only of value if airflow expected to be less than ~30% of design airflow e.g. if there are small Zone Groups

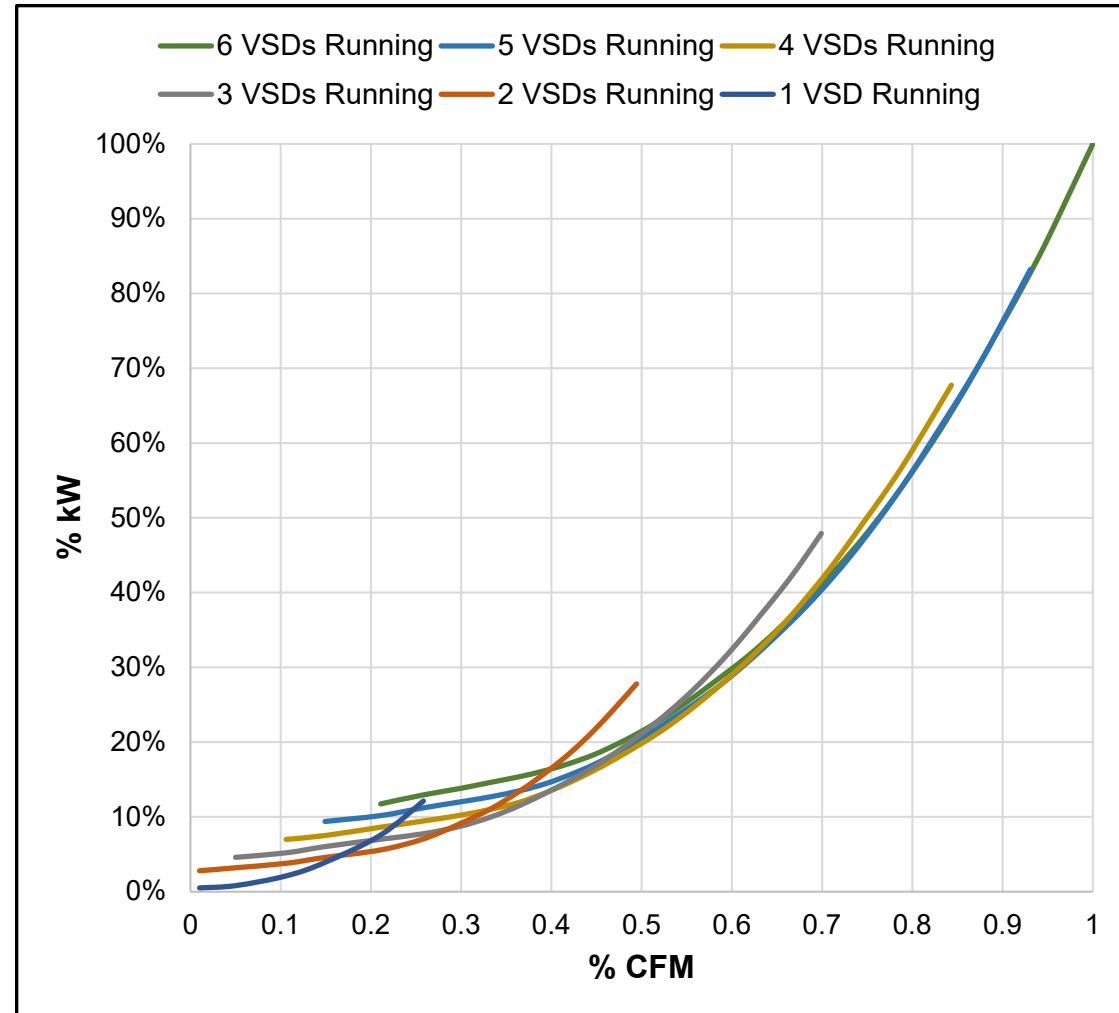

# **Tip#4 Control minimum outdoor air using DP across a fixed orifice**



# Outdoor airflow measurement is inaccurate!

- Many causes of error
  - Low air speeds, near detection limits of many sensors
    - Especially at minimum outdoor air rates
  - Non-uniform direction of air flow & turbulence
    - Partly due to limited space in AHUs
  - OA temperature and density vary
  - Sensors may be fouled due to moisture and dust
  - Effects of wind
- Controlling airflow within 10% and 15% per some codes and LEED is seldom actually possible
  - Our secret – don't tell GBCI or AHJs 😊

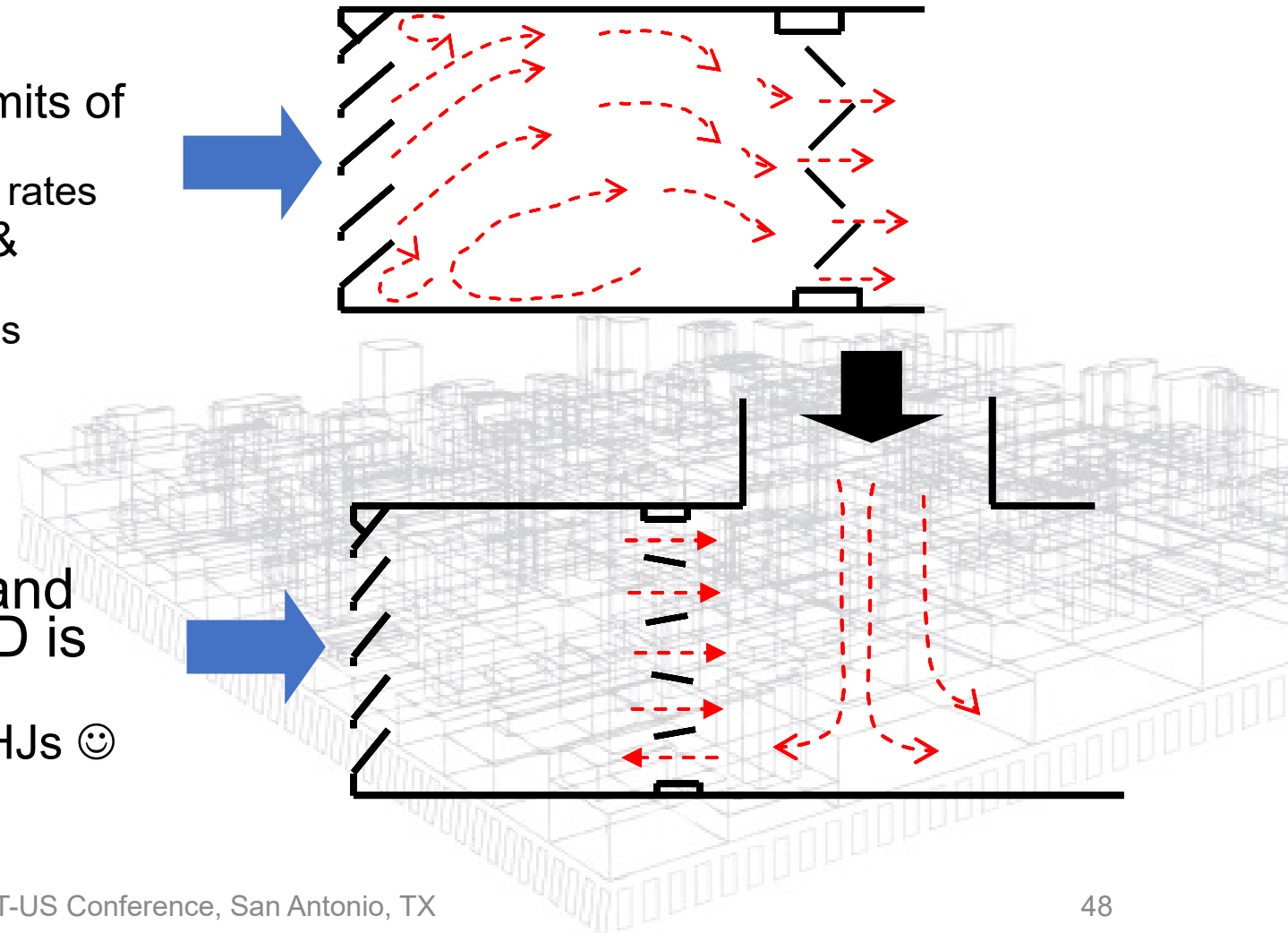



# Separate outdoor air section difficult to control in cold weather

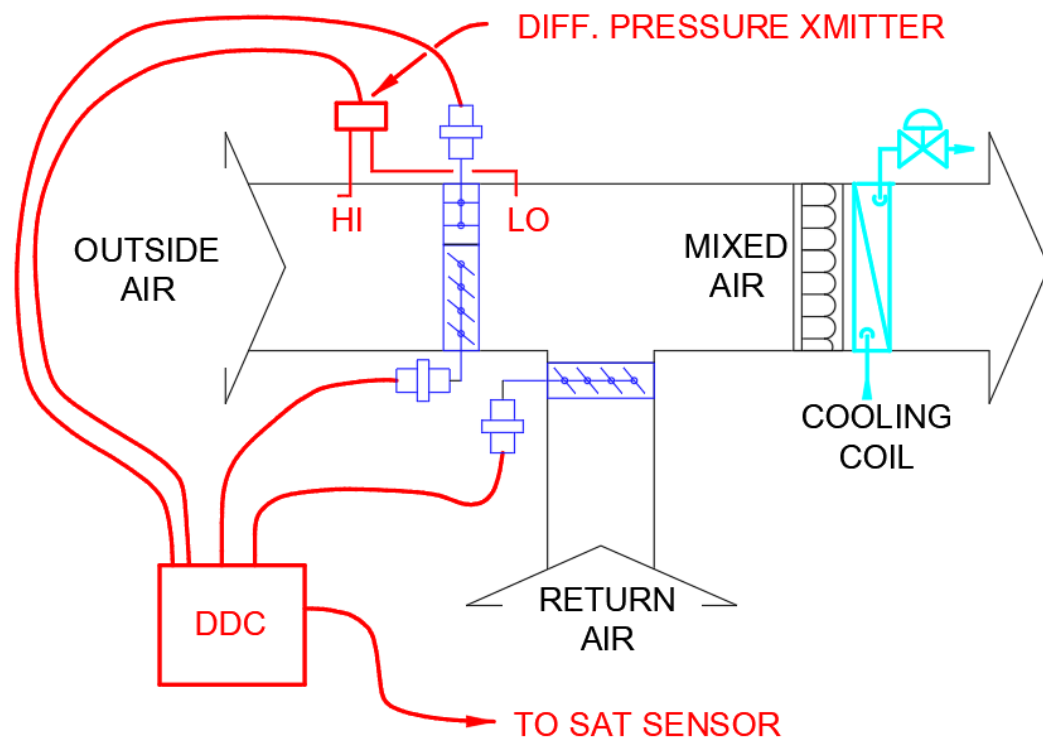

Since outdoor airflow through economizer section is unknown, not clear when return air damper control gets enabled

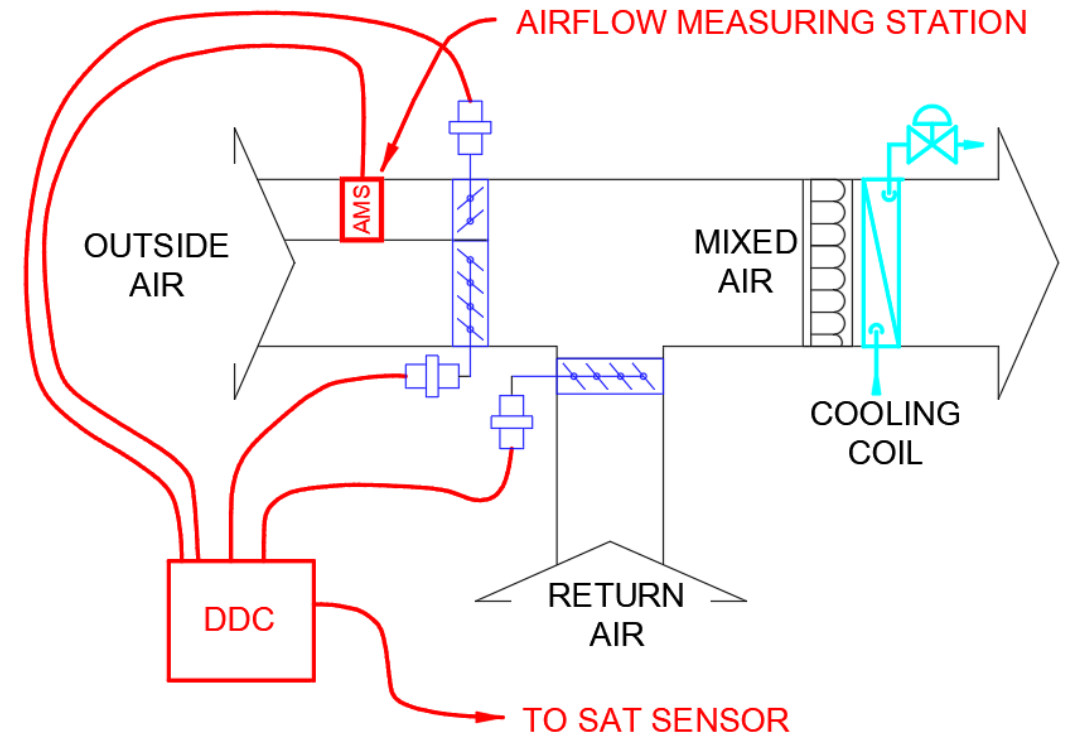

Also does not work with RP-1747 DCV logic – need to know entire outdoor airflow rate

# Better to measure all outdoor airflow

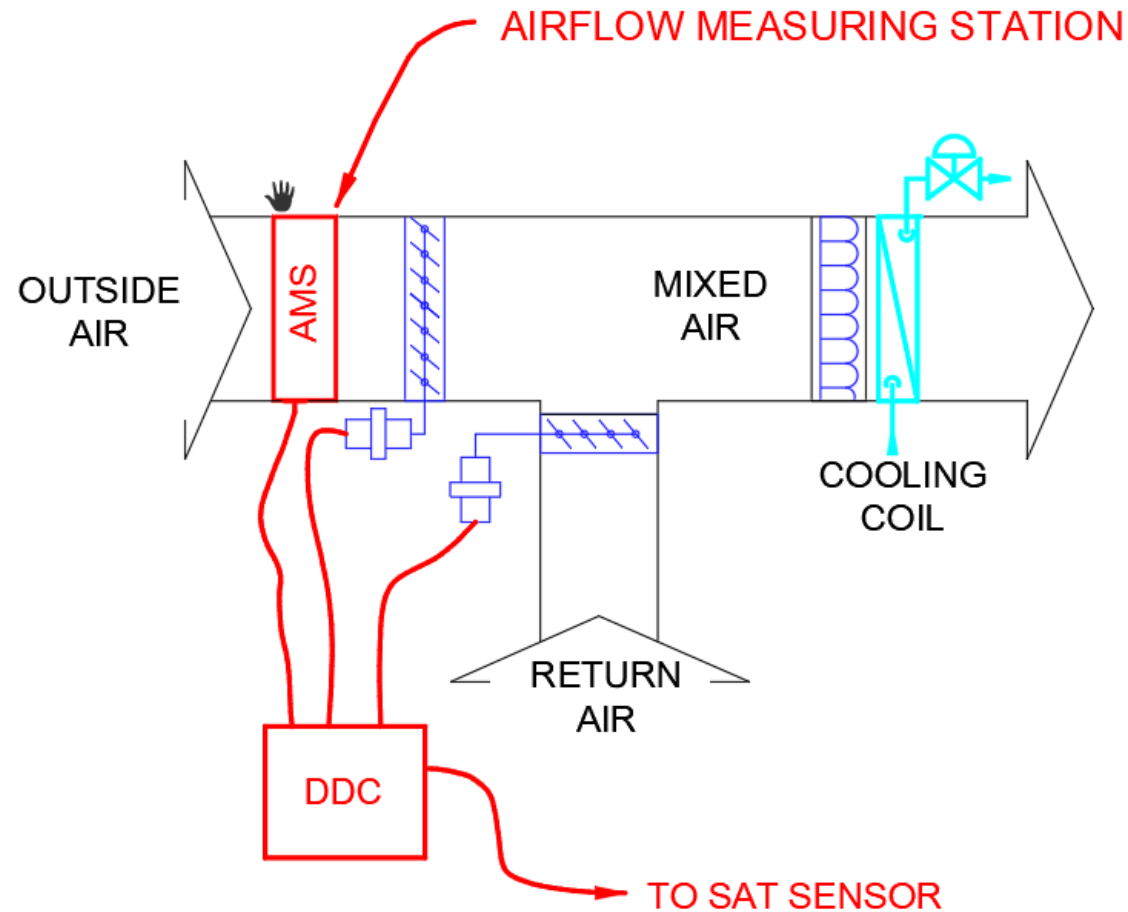

Continuous control loop maintains outdoor air at minimum with output that simply limits return air damper position. Very simple

Also works with RP-1747 DCV sequences

But what sensor can be used to measure airflow over such a wide range down to ~150 fpm?

# Most AFMS do not work very well in typical applications

- Unable to read low velocities
- Affected by asymmetric velocity profile
- Affected by dirt, rainwater, snow
- Extra space needed

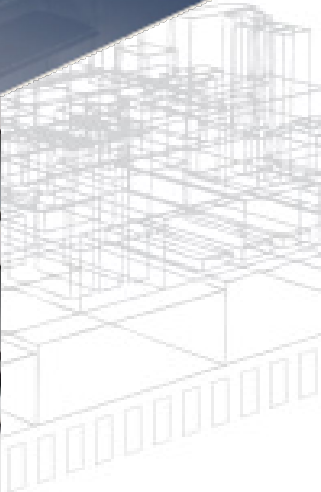
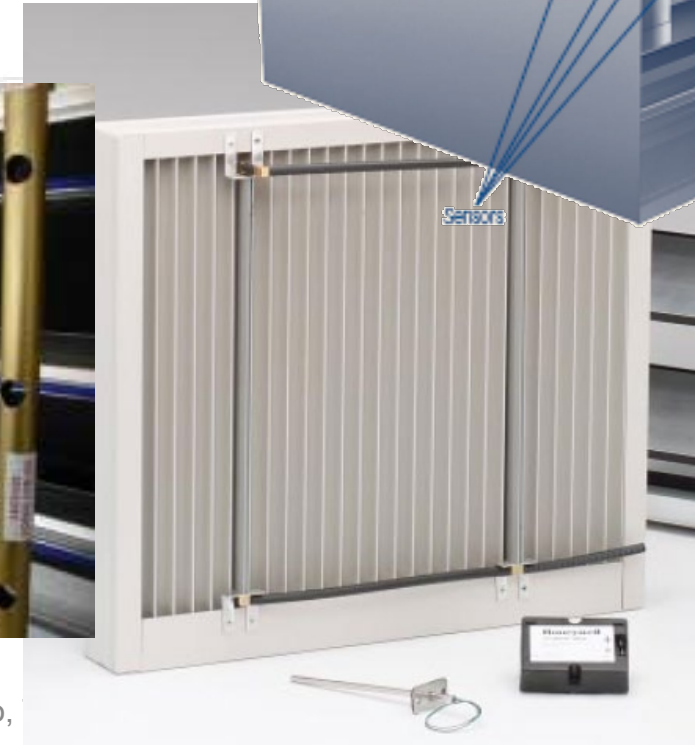
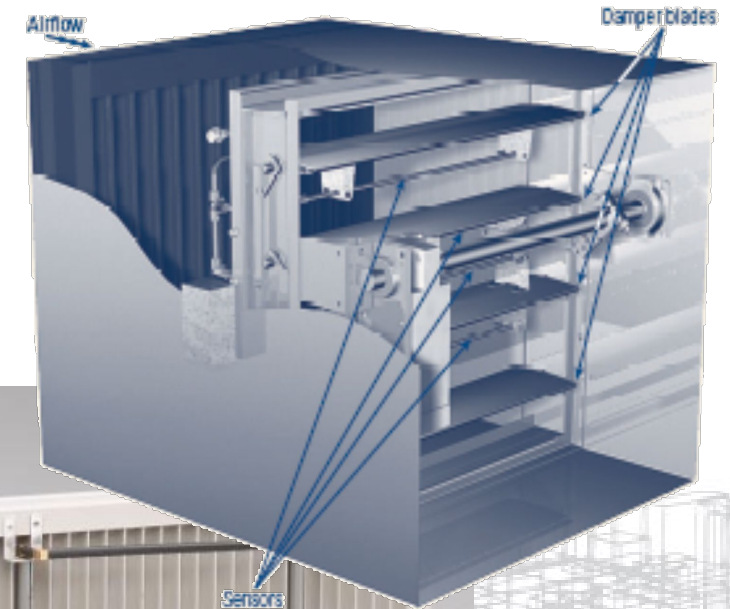

# DP across a fixed orifice

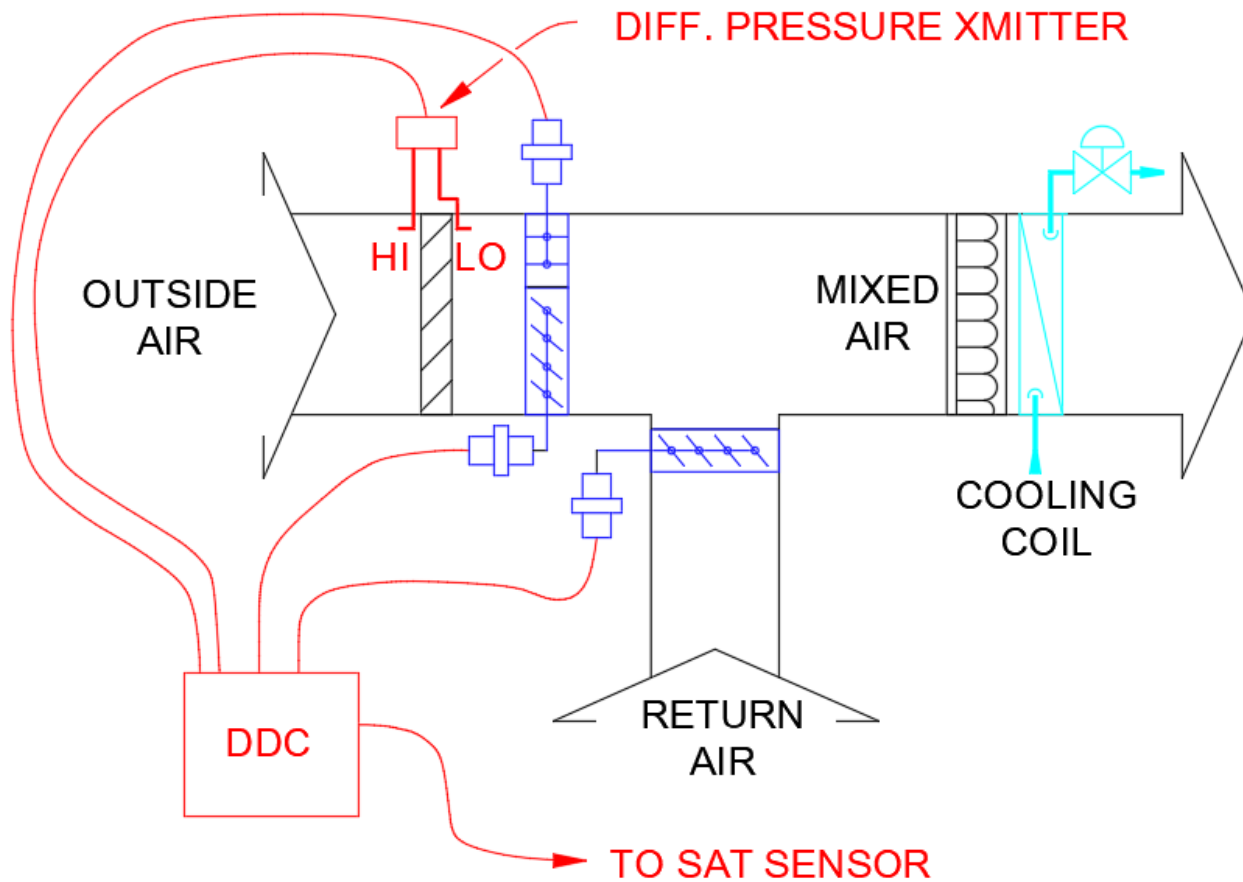

## Requires:

- DP transmitter accurate in 0 to 0.1" range
- Optional temperature/density correction
- Fixed orifice (e.g. louver, mesh screen) that creates ~0.06" DP at design velocity



# DP across a fixed orifice

- Using the louver DP as the signal mitigates effects of non-uniform velocity and wind
- Provides a 2x to 3x higher signal than a velocity or velocity pressure sensor – measures accurately down to ~150 fpm
- Avoids field calibration if fixed orifice DP is accurately known
- Less prone to fouling or damage from dirt, rain, or snow
  - Very reliable and low maintenance costs
- No added AHU length required

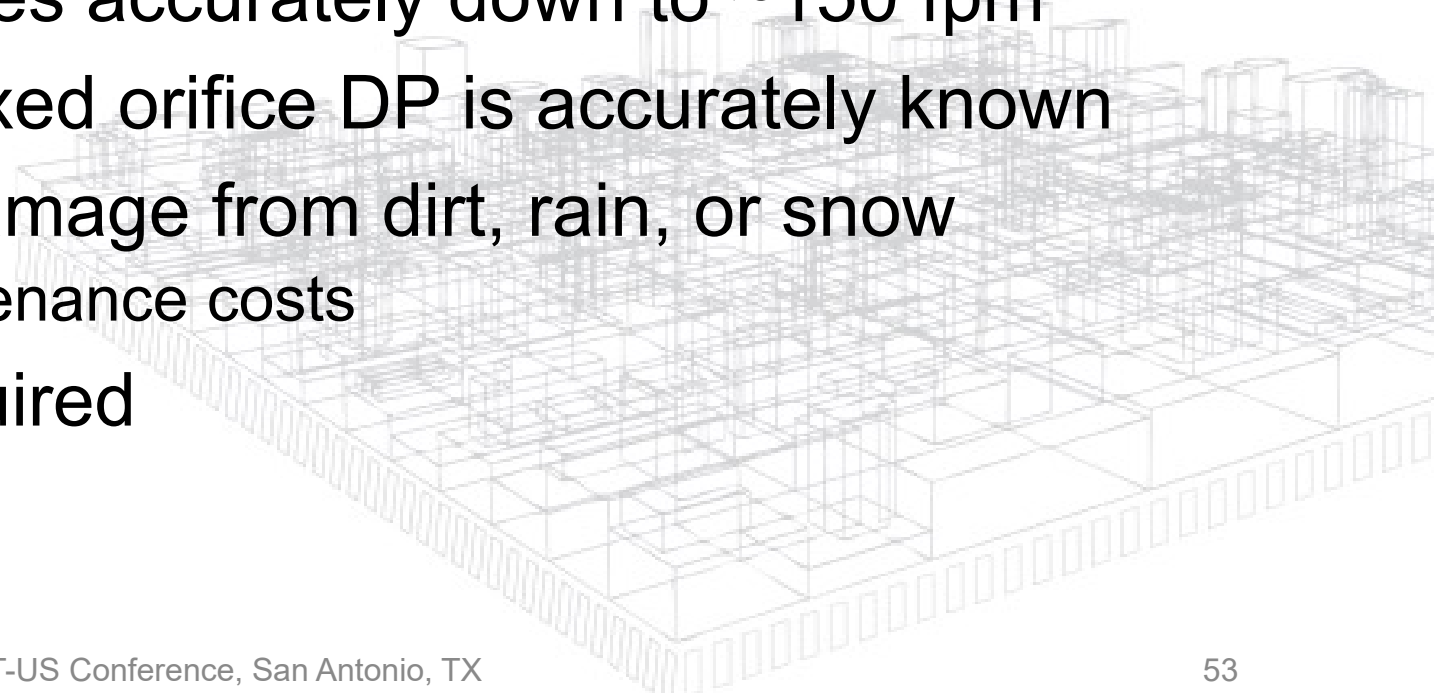

# Staged OADs and RADs for large AHUs

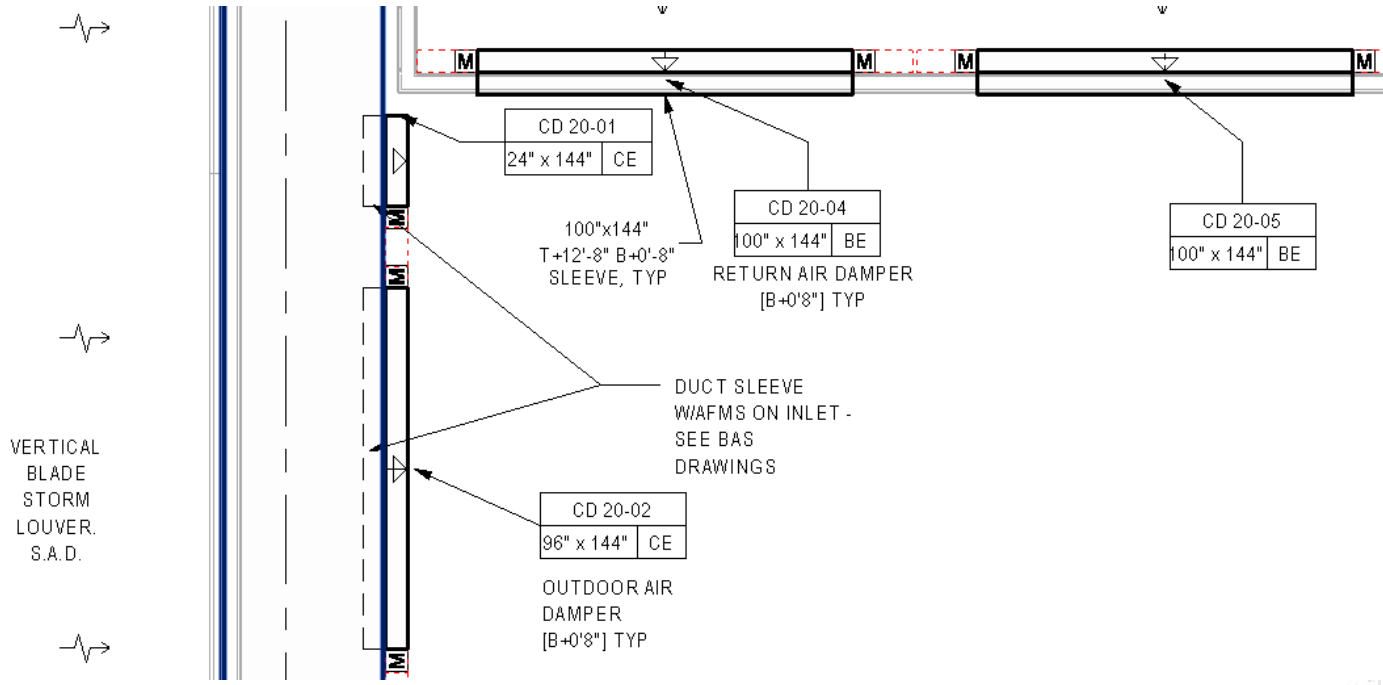

Plan

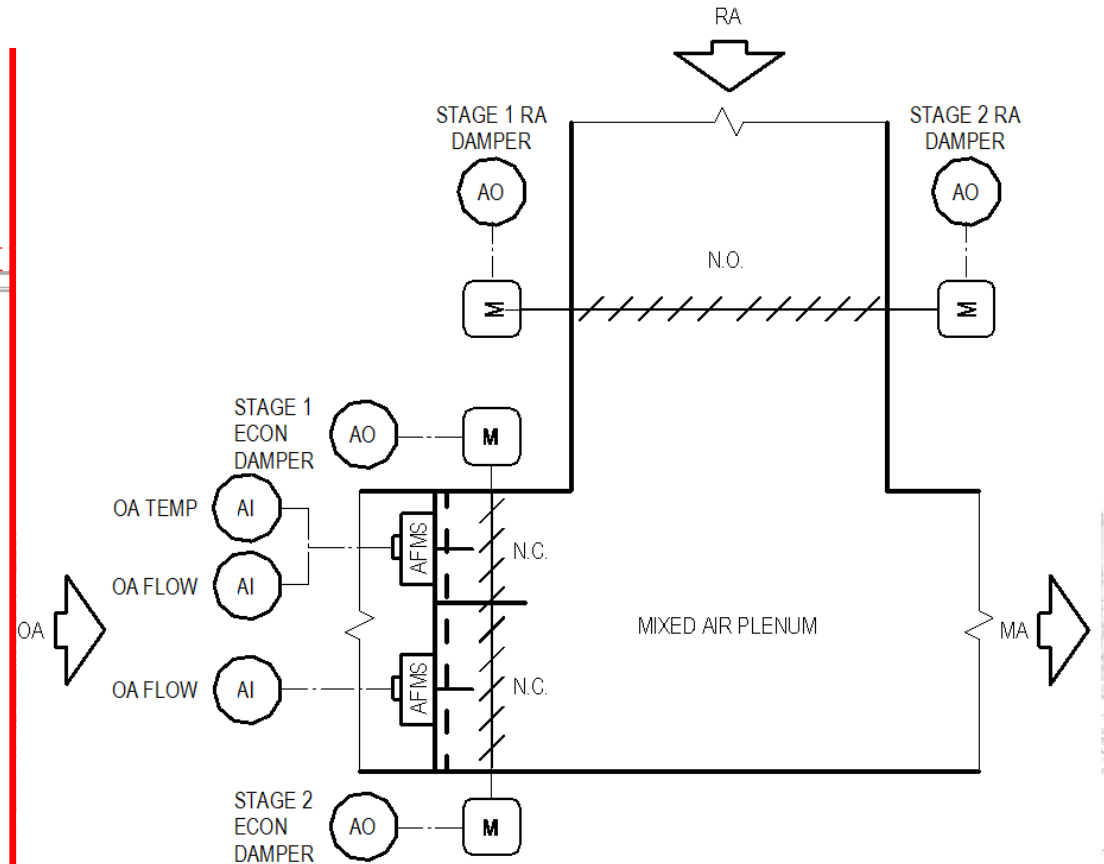

Control Schematic

# Summary – VAV Design Tips

- Tip#1: Use Guideline 36 Sequences
  - This is the most important tip!
- Tip#2: Set VAV Box minimum airflow to minimum ventilation rate
  - Recent changes to Standard 62 make this simple
- Tip#3: Use Fan Arrays
  - No downside, allows very large AHUs
- Tip#4: Control minimum outdoor air using DP across fixed orifice
  - Finally a decent AFMS!

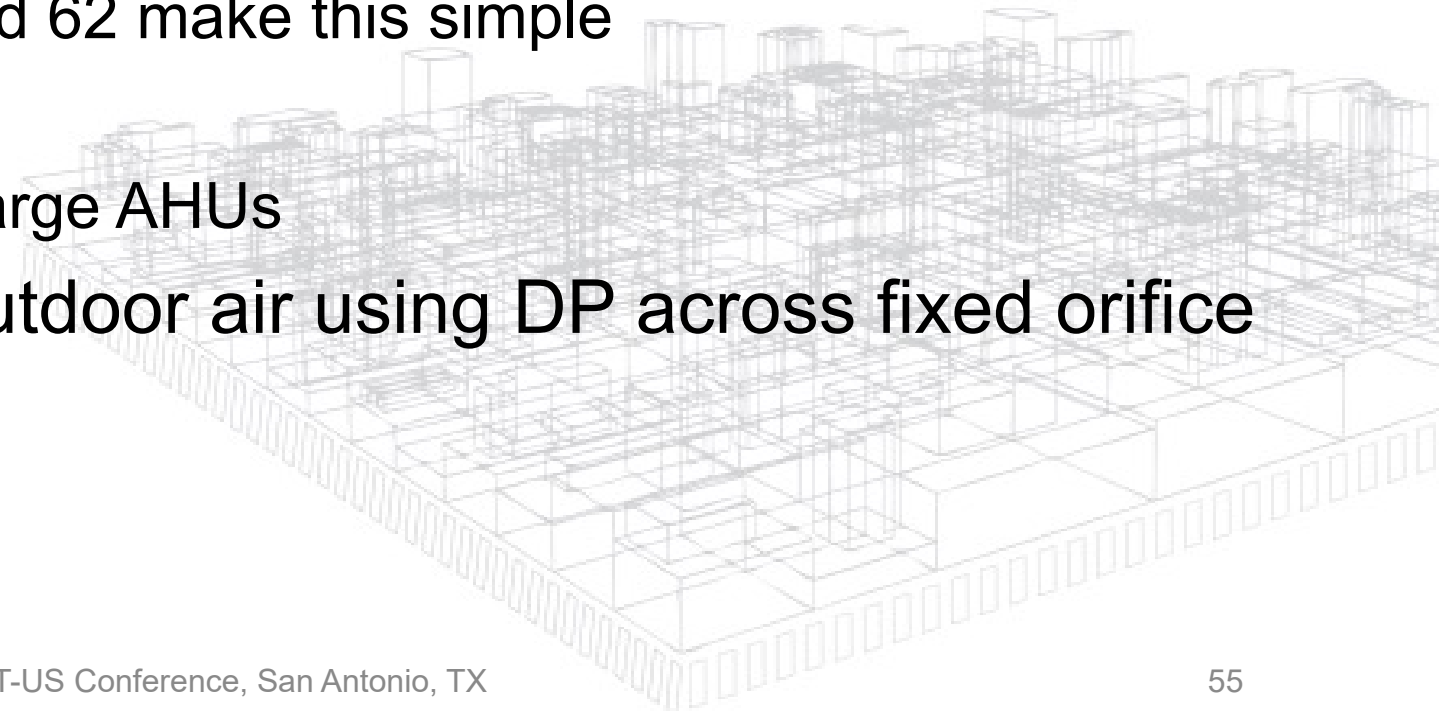

# Bibliography

- ASHRAE Guideline 36-2018 High Performance Sequences of Operation for HVAC Systems (published probably May 2018)
- ASHRAE Standard 62.1-2016 Addendum f, (published probably May 2018)
- Dickerhoff D., Stein J.; “Stability and Accuracy of VAV Terminal Units at Low Flow”, PG&E 0514
- Lui R., Wen J.; “Stability and Accuracy of VAV Box Control at Low Flows”, ASHRAE 1353-RP
- Taylor S. “Dual Maximum VAV Box Logic”, ASHRAE Journal, December 2012
- Arens et al; RP 1515, Thermal and Air Quality Acceptability in Buildings that Reduce Energy by Reducing Minimum Airflow from Overhead Diffusers, ASHRAE 1515-RP
- Taylor S. “Mega-Air Handling Units, ASHRAE Journal, March 2018
- Taylor, S., VAV System Static Pressure Setpoint Reset, ASHRAE Journal, June 2007
- Taylor, S. Resetting Setpoints Using Trim & Respond Logic, ASHRAE Journal, November 2015



# Questions?

**Steve Taylor, PE, FASHRAE**  
**Principal, Taylor Engineering LLC, Alameda, CA**  
**[staylor@taylor-engineering.com](mailto:staylor@taylor-engineering.com)**

