



AMCA International

Air System Motor, Drives – Sizing and Selection

Trinity Persful

VP Marketing, Twin City Fan, Minneapolis, MN

tpersful@tcf.com

Air System Engineering & Technology (ASET) Conference–US

San Antonio, TX • Hyatt Regency San Antonio Riverwalk • March 6 - 7, 2018

Copyright
AMCA International • www.amca.org

Professional Development Hours (PDH) Certificates

The Air Movement and Control Association International (AMCA), has met the standards and requirements of the Registered Continuing Education Providers Program. Credit earned on completion of this program will be reported to the RCEP. A certificate of completion will be issued to each participant. As such, it does not include content that may be deemed or construed to be an approval or endorsement by NCEES or RCEP.



Copyright Materials

This educational activity is protected by U.S. and International copyright laws. Reproduction, distribution, display, and use of the educational activity without written permission of the presenter is prohibited.

© AMCA International

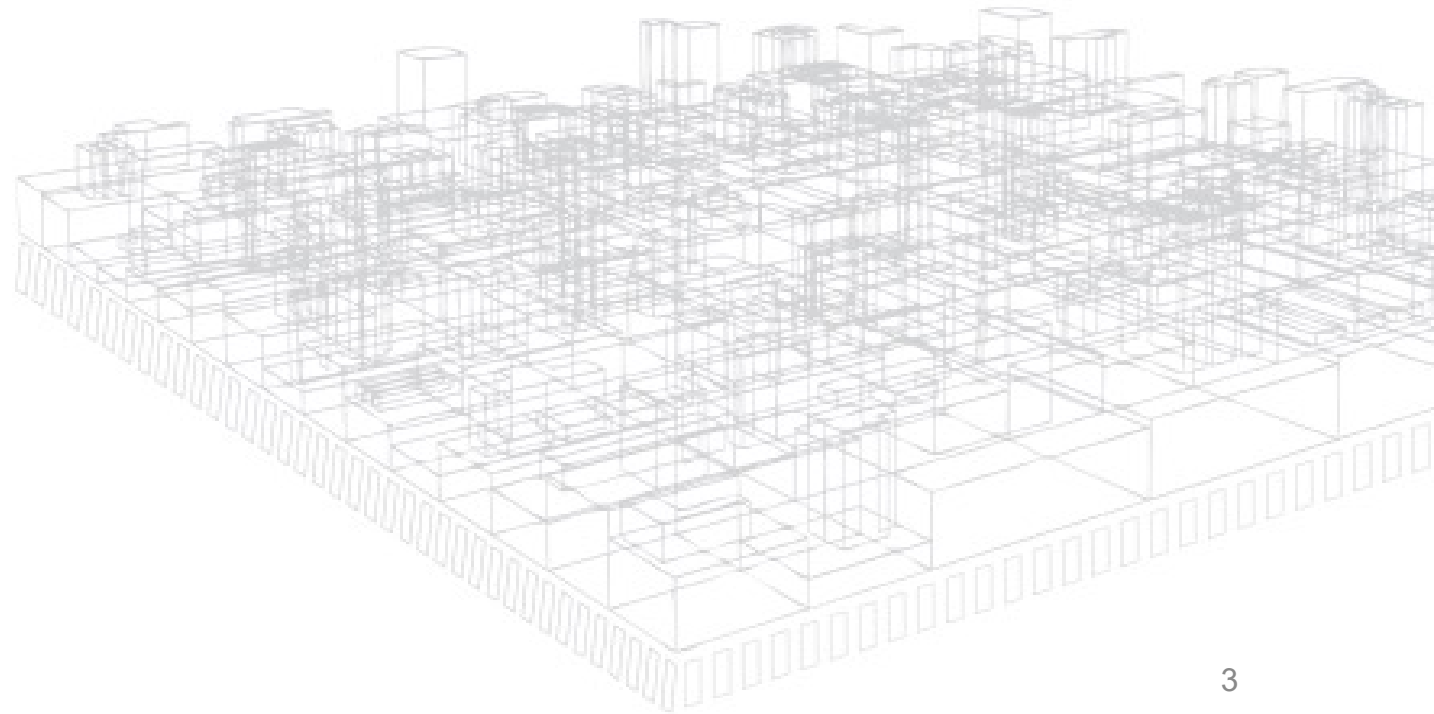

Learning Objectives

- Understand the role of fans in energy efficiency
- Understand reference fan calculations using AMCA 207/208
- Become familiar with part load energy calculations using AMCA 207/208

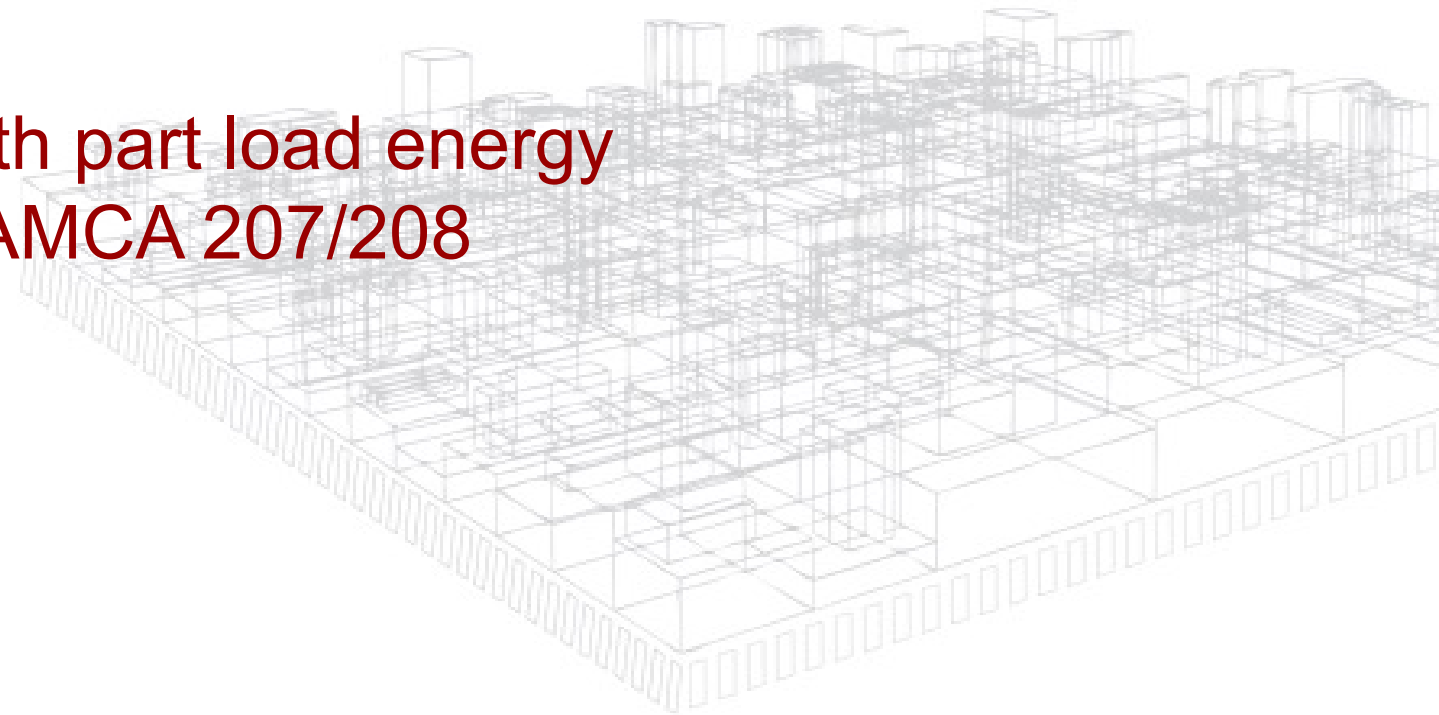

Structure

1. Brief review of Fan Efficiency Index (FEI)
 - $FEI = FEP_{ref} / FEP_{act}$
2. Reference Fan Electrical Input Power (FEP_{ref})
 - Based off of flow and pressure of operating point = max power allowed
 - Calculated transmission loss
 - Calculated motor loss
3. Actual Fan Electrical Input Power (FEP_{act})
 - Wire to air tests or
 - Fan power + calculations for belt losses, coupling, vfd losses, control losses, motor losses

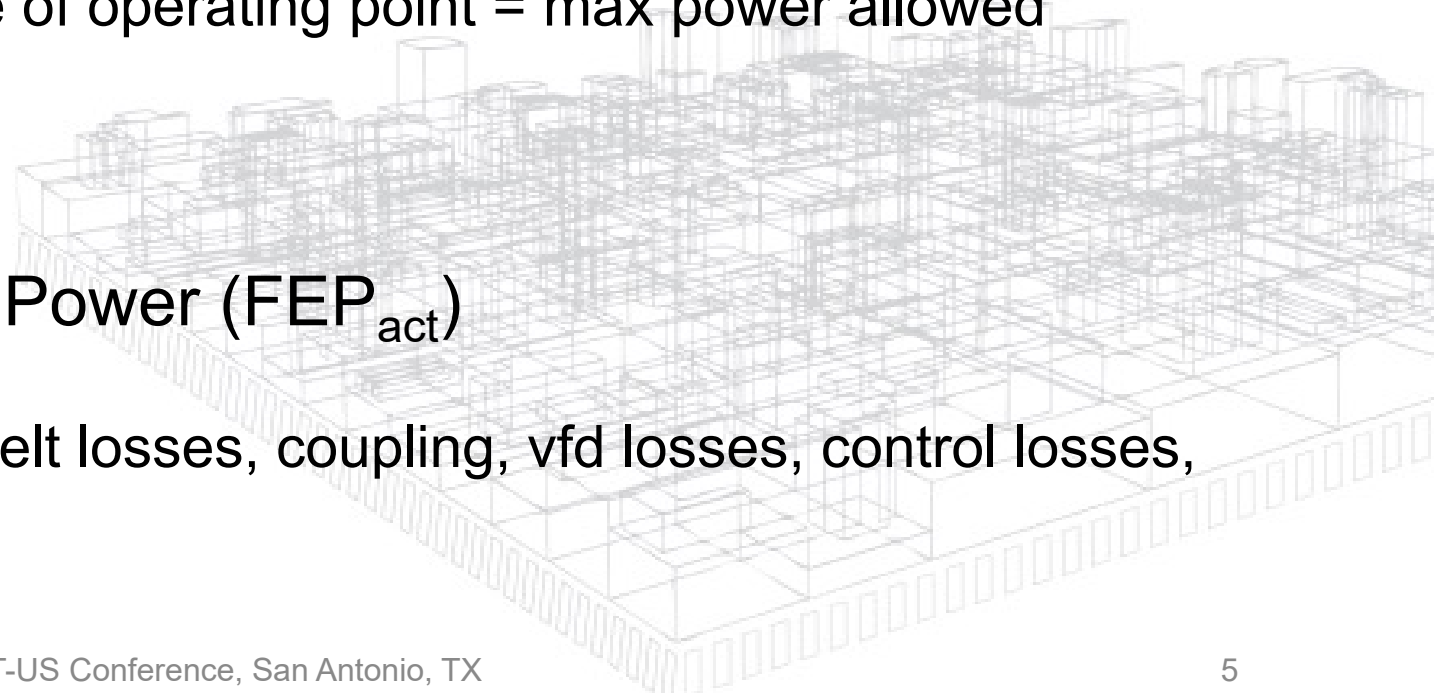

AMCA 207 Standard

AMCA 207 – Fan System Efficiency and Fan System Input Power Calculation

- Provides a method to estimate the input power and efficiency of a fan SYSTEM
- Models commonly used components
- Scope – fans covered by AMCA 210/211, AMCA 230 (circulating fans), AMCA 260 (induced flow)

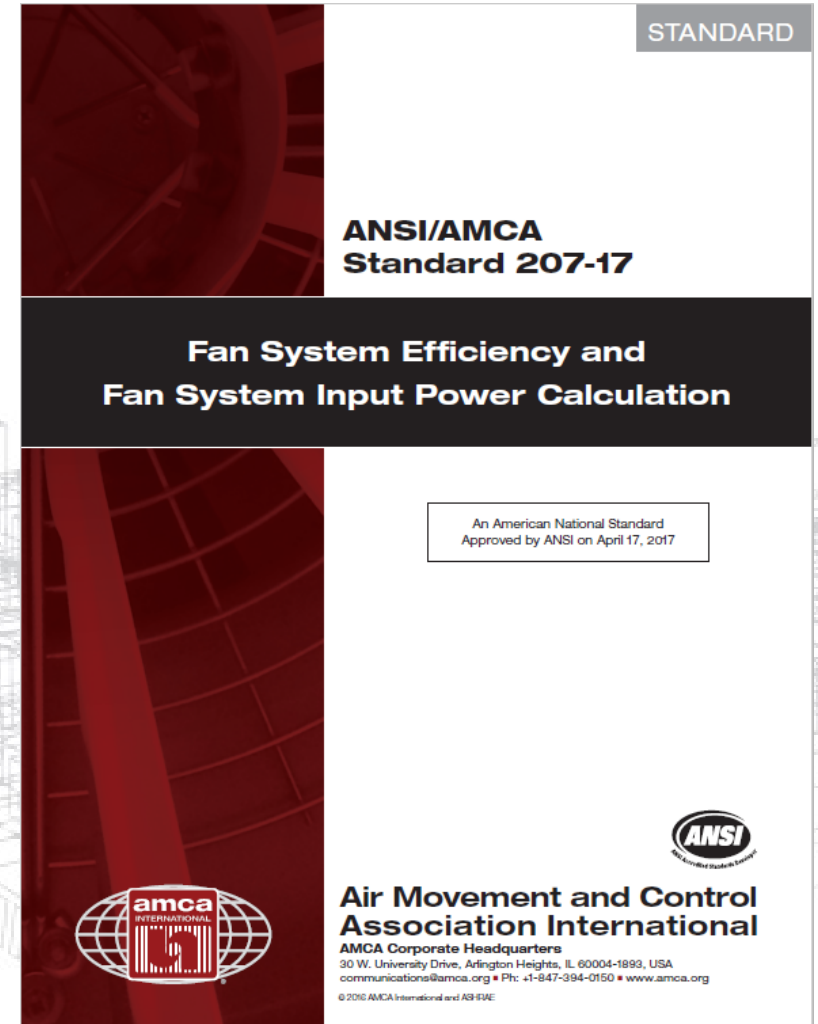

AMCA 208 Standard

AMCA 208 – Calculation of the Fan Energy Index (FEI)

- Defines the FEI
- Allows a comparison basis to compare fan energy performance
- Regulatory bodies can use to define the requirements

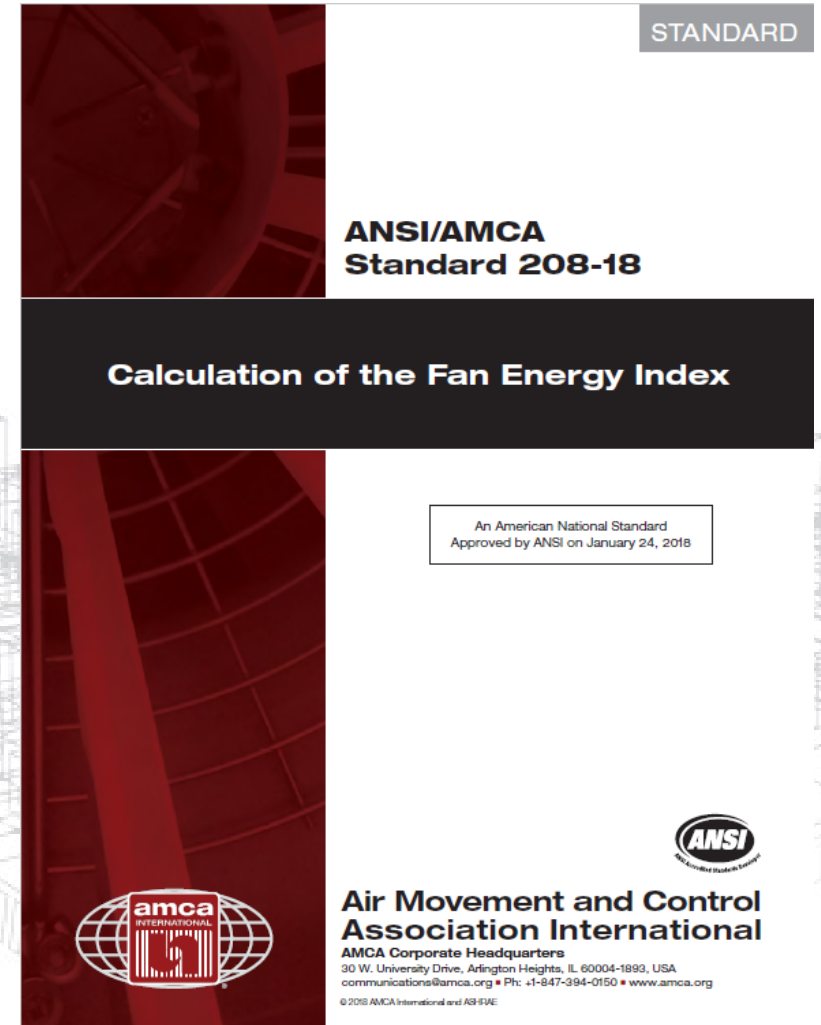

What's a Fan?



+

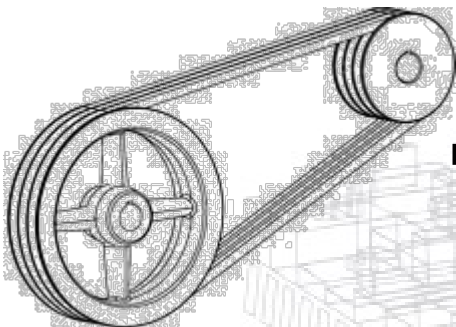

+

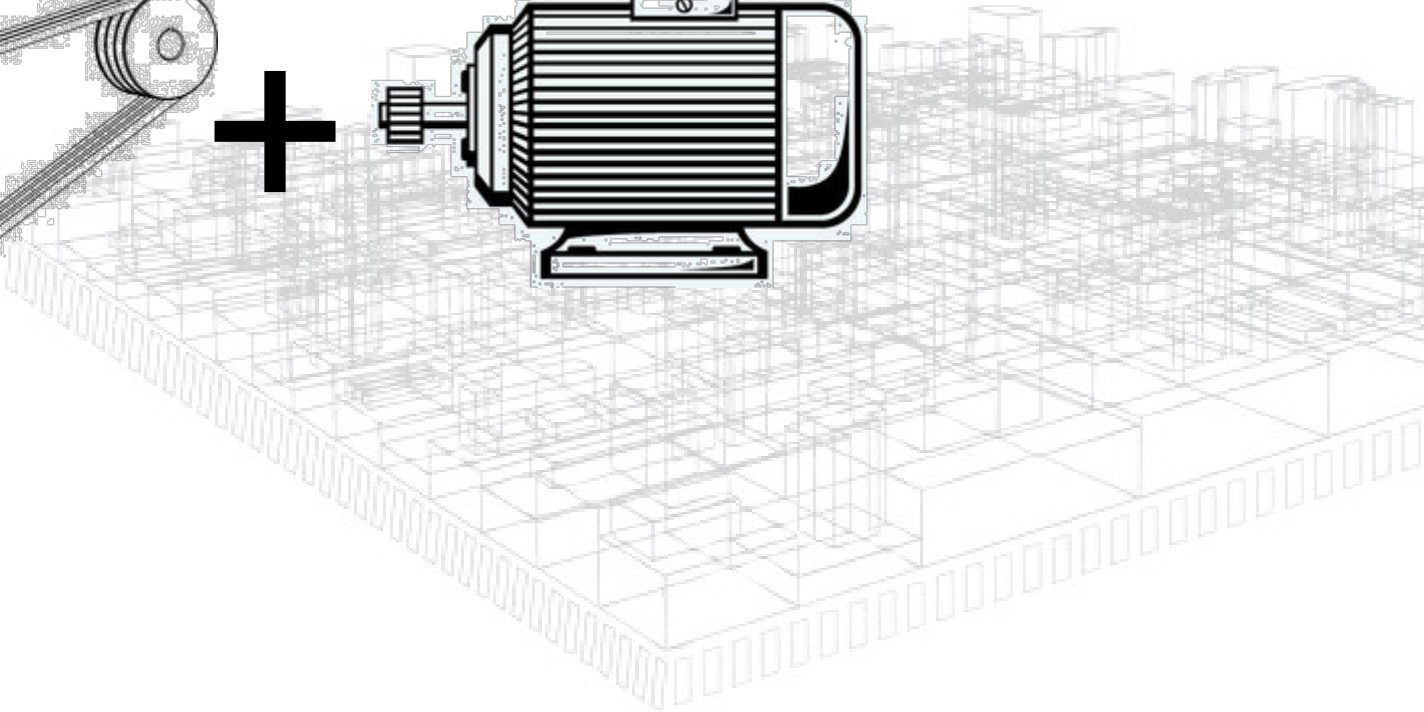
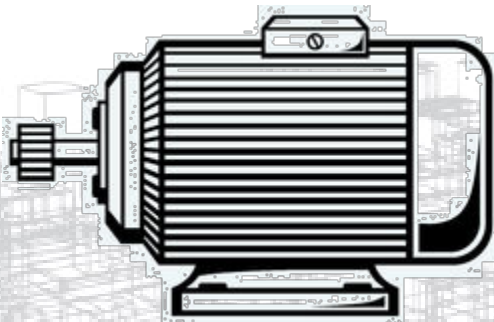

Intro to FEI

In the most simple terms, we compare a fan selection to a reference(default) fan.

How well does the selection compare?

$$FEI = \frac{\textit{Reference Fan Electrical Input Power}}{\textit{Actual Fan Electrical Input Power}} = \frac{FEP_{ref,i}}{FEP_{act,i}}$$

FEI = Fan Efficiency Index

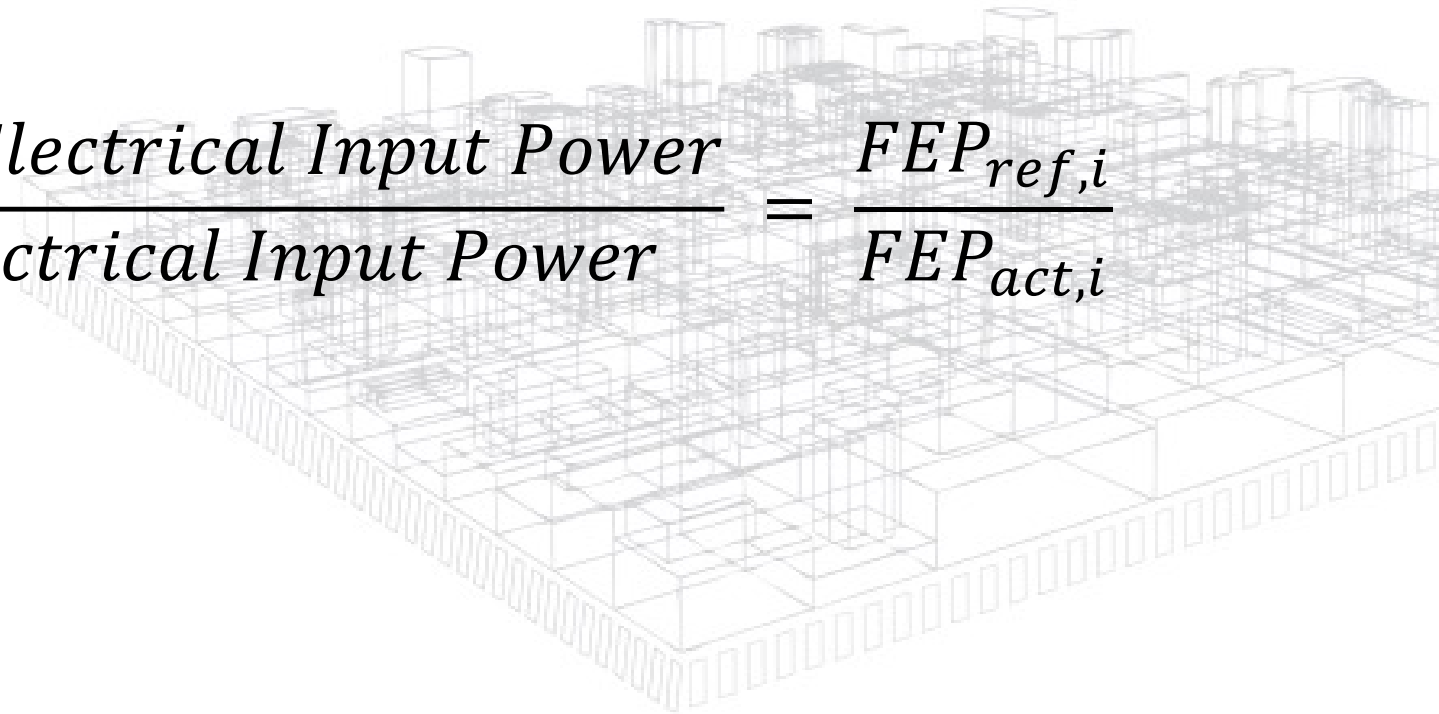

Fan Power

Wire to Air Power

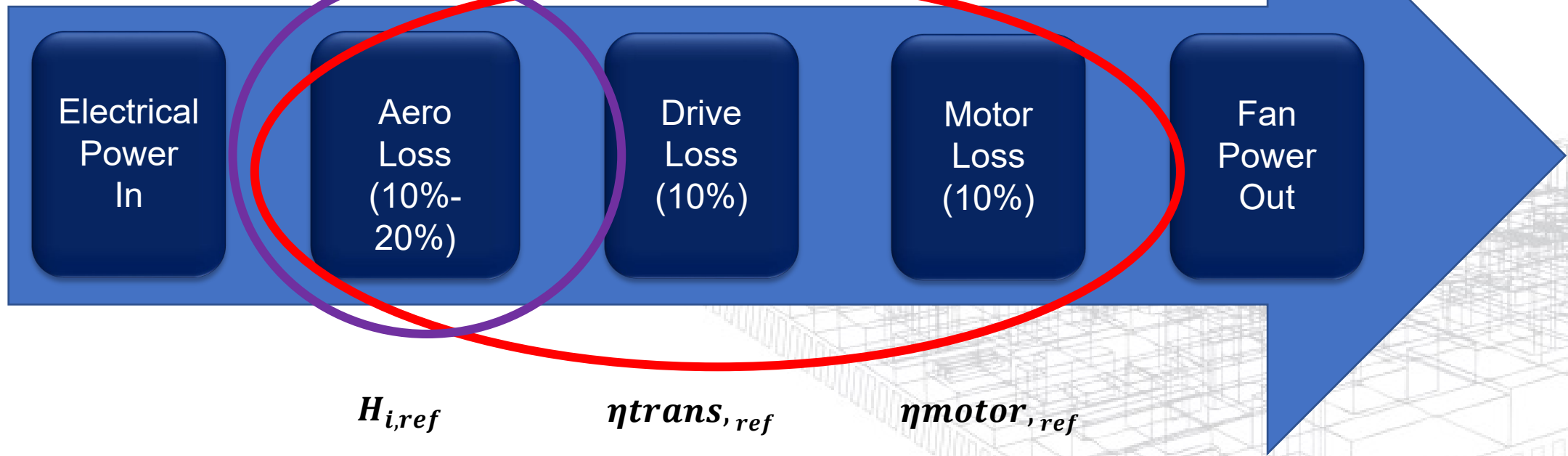

$H_{i,ref}$

$\eta_{trans,ref}$

$\eta_{motor,ref}$

Reference Fan Electrical Input Power (FEP_{ref})

$$FEP_{ref,i} = H_{i,ref} \left(\frac{1}{\eta_{trans,ref}} \right) \left(\frac{1}{\eta_{motor,ref}} \right) \times .7457$$

H_i = Fan shaft power (kW, hp)

η = efficiency

The reference fan is defined as one that requires a reference fan shaft power, uses a V-belt drive, has a motor based on IE3 for 4 pole, 60Hz with no speed control.

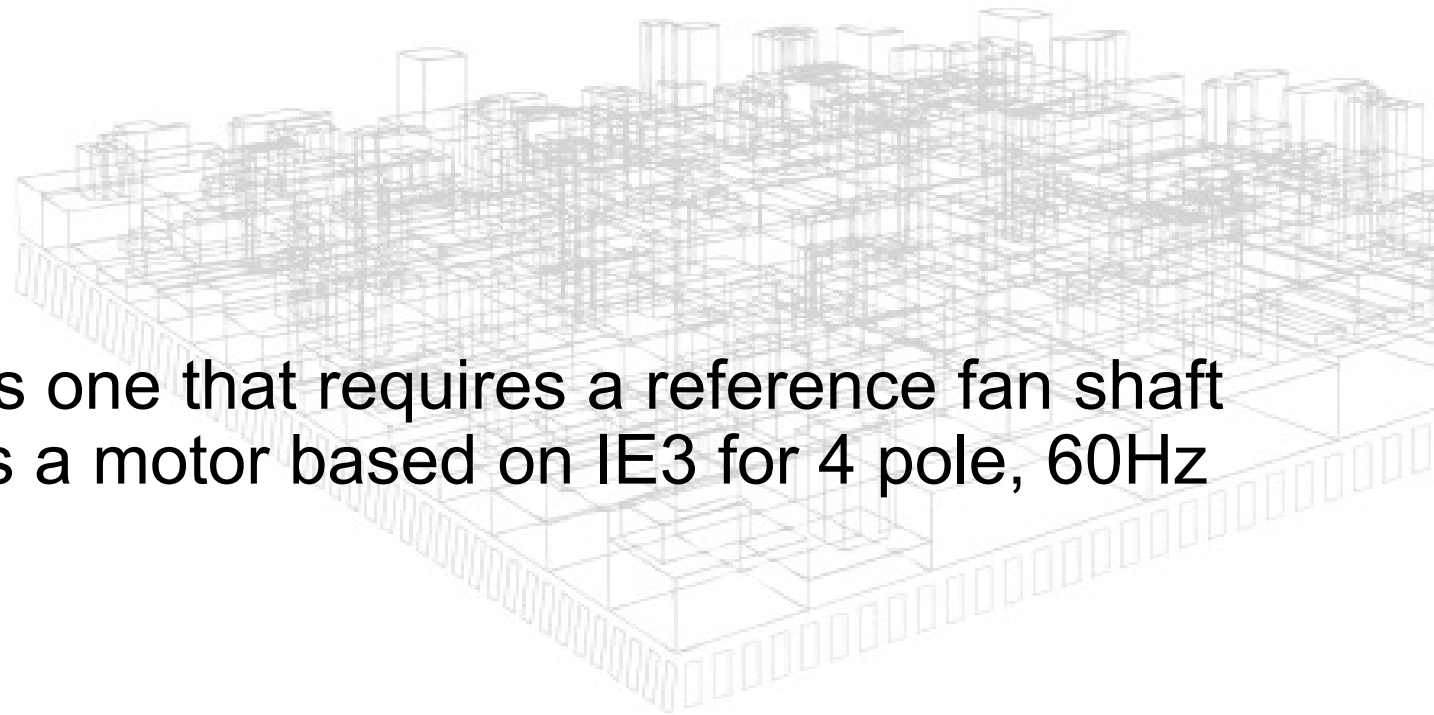

Reference Fan Electrical Input Power (FEP_{ref})

$$FEP_{ref,i} = H_{i,ref} \left(\frac{1}{\eta_{trans,ref}} \right) \left(\frac{1}{\eta_{motor,ref}} \right) \times .7457$$

$$H_{i,ref} = \frac{(Q_i + Q_0) \left(P + P_0 \times \frac{\rho}{\rho_{std}} \right)}{6,343 \times \eta_o}$$

Q_i - selected fan airflow

P_i - selected fan total pressure (ducted), or static pressure (nonducted)

P - air density

ρ_{std} - standard air density

Q_0 - 0.118 m³/s (SI), or 250 cfm (IP)

P_0 - 100 Pa (SI), or 0.40 in.wg (IP)

η_o - 66% for ducted applications and 60% for nonducted applications

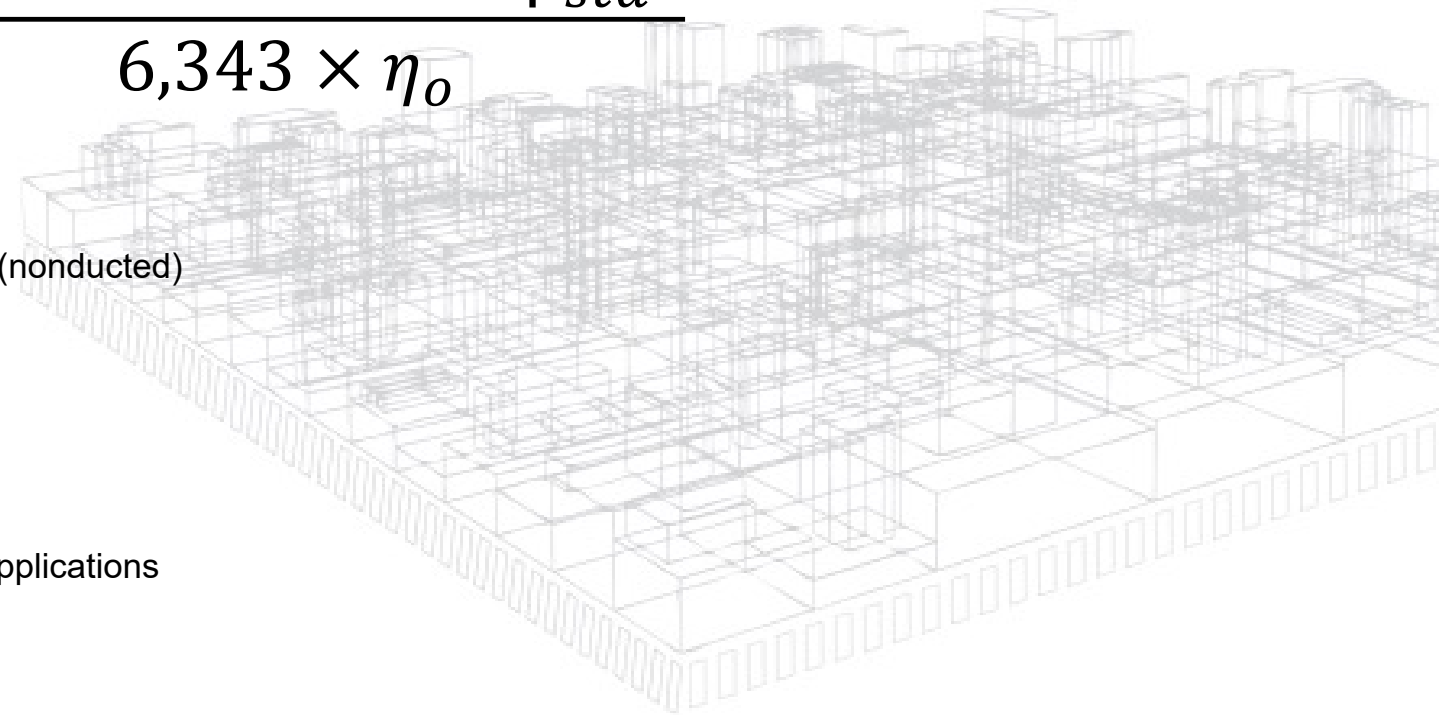

Reference Fan Electrical Input Power (FEP_{ref})

$$FEP_{ref,i} = H_{i,ref} \left(\frac{1}{\eta_{trans,ref}} \right) \left(\frac{1}{\eta_{motor,ref}} \right) \times .7457$$

The reference fan transmission efficiency is calculated using the same equations as found in ANSI/AMCA Standard 207 for V-belt drives. The efficiency of a V-belt transmission is calculated as:

Reference Fan Electrical Input Power (FEP_{ref})

Transmission efficiency = V-belt power transmission

$$\eta_B = 0.96 \left(\frac{H_i}{H_i + 2.2} \right)^{0.05}$$

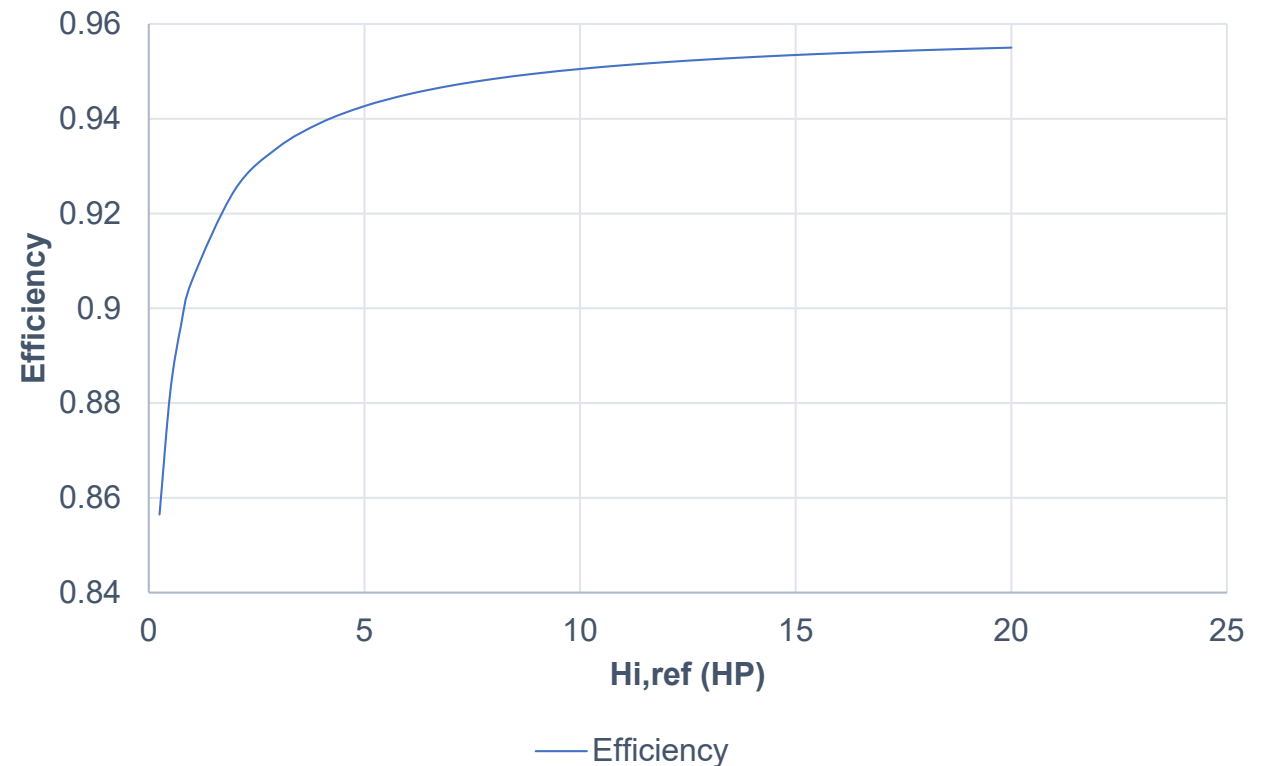

Reference Fan Electrical Input Power (FEP_{ref})

$$FEP_{ref,i} = H_{i,ref} \left(\frac{1}{\eta_{trans,ref}} \right) \left(\frac{1}{\eta_{motor,ref}} \right) \times .7457$$

- The reference fan = a motor efficiency based on the IE3, 4 pole 60 Hz motor.
- To simplify the calculation - a curve fit is used through the IE3 motor efficiency requirements.
- The result is a reference motor efficiency that varies continuously based on the required motor output power.

Reference Fan Electrical Input Power (FEP_{ref})

$$FEP_{ref,i} = H_{i,ref} \left(\frac{1}{\eta_{trans,ref}} \right) \left(\frac{1}{\eta_{motor,ref}} \right) \times .7457$$

$\eta_{motor,ref} =$

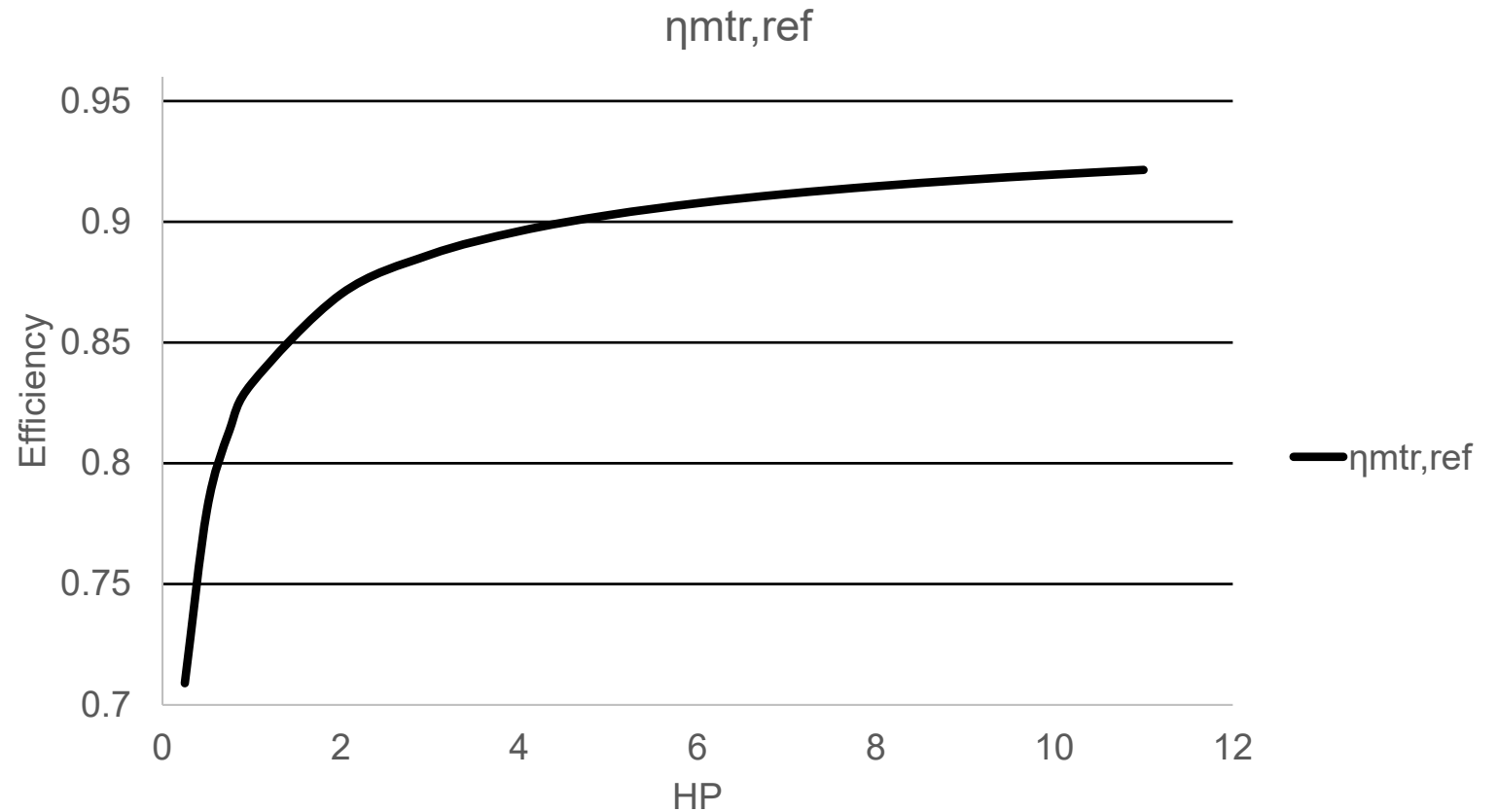

Fan Configuration	Motor Type	FEPact Determination	Example Applications
Fan for which the motor is not yet selected	N/A	Default motor efficiency calculation	<ul style="list-style-type: none"> Fans sold without motors Catalogs used for fans prior to motor selection
Fan with motor	Any	Wire to air measurements (211)	<ul style="list-style-type: none"> Motors for which no test standards apply
	Polyphase induction motors within the scope of AMCA 207	AMCA 207 Calculations	<ul style="list-style-type: none"> 3 phase regulated motors 3 phase non-regulated (AO, XP, 2 speed, etc.)
	Motors for which performance can be measured in accordance with a known standard	Motor tests	<ul style="list-style-type: none"> Single phase regulated motors Single phase non-regulated 3 phase fractional motors
	Motors where AMCA 207 does not apply	Default motor efficiencies	
Fan with motor and speed control	Any	Wire to air measurements (211)	<ul style="list-style-type: none"> Motors for which no test standards apply
	Polyphase induction motors, reg/nonreg within AMCA207	AMCA 207 Calculations	<ul style="list-style-type: none"> 3 phase regulated motors 3 phase non-regulated (AO, XP, 2 speed, etc.)



Actual Fan Electrical Input Power (FEP_{act})

Now that the reference fan is defined, let's define the **actual** power consumption – FEP_{act} .

$$FEP_{act} = \text{Shaft to air} + \text{transmission loss} + \text{coupling loss} + \text{motor loss} + \text{VFD loss}$$

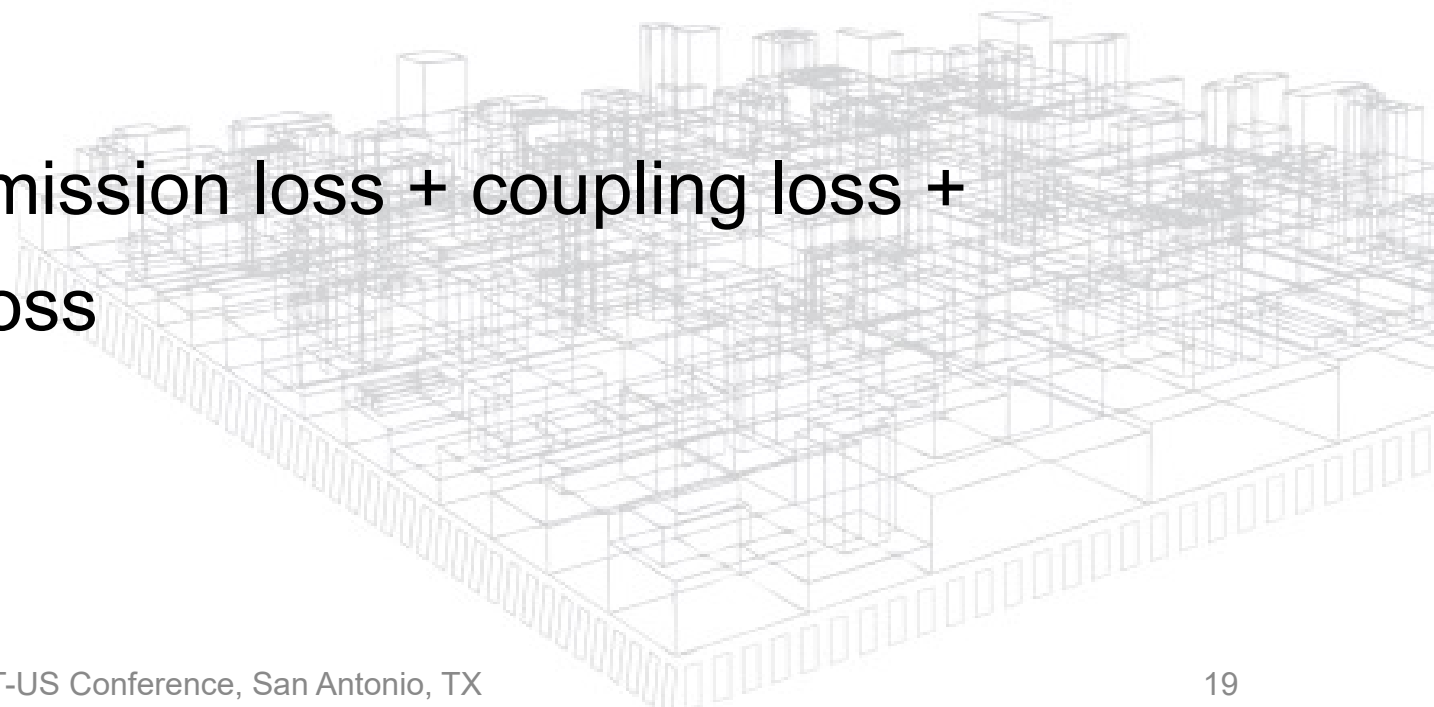

Actual Fan Electrical Input Power (FEP_{act})

V-belt power transmission

- The efficiency of a V-belt transmission is calculated as:

$$\eta_B = 0.96 \left(\frac{H_i}{H_i + 2.2} \right)^{0.05}$$

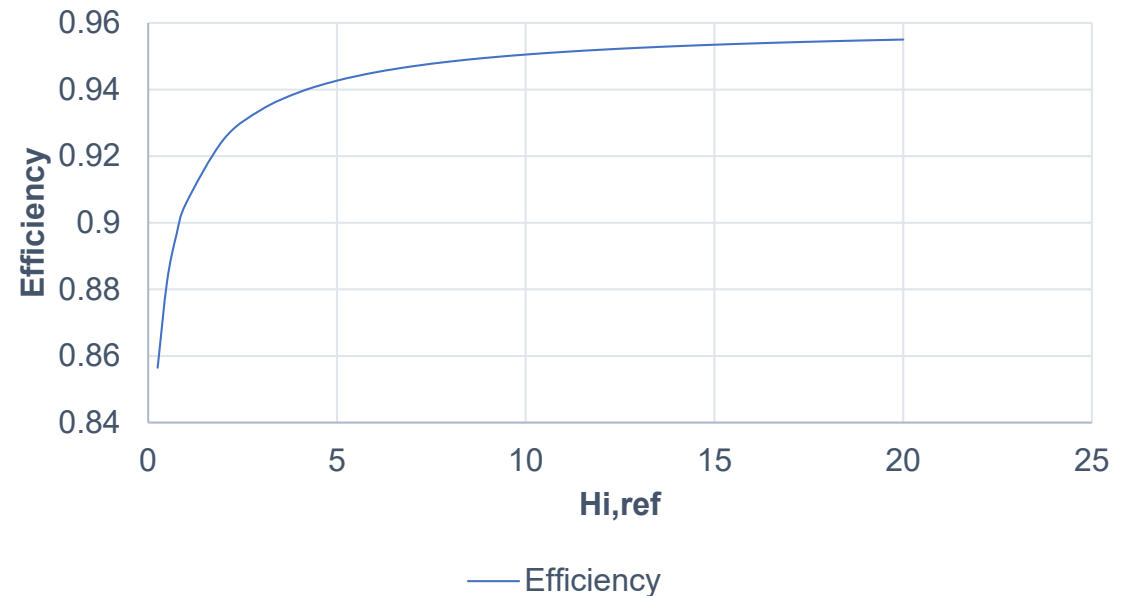

Actual Fan Electrical Input Power (FEP_{act})

Synchronous belt power transmission

- The efficiency of a synchronous belt transmission is calculated as:

$$H_i \leq 1.34 \text{ hp}, \eta_B = 0.94$$

$$1.34 \text{ hp} < H_i \leq 6.7 \text{ hp}, \eta_B = 0.00746 H_i + 0.93$$

$$H_i > 6.7 \text{ hp}, \eta_B = 0.98$$

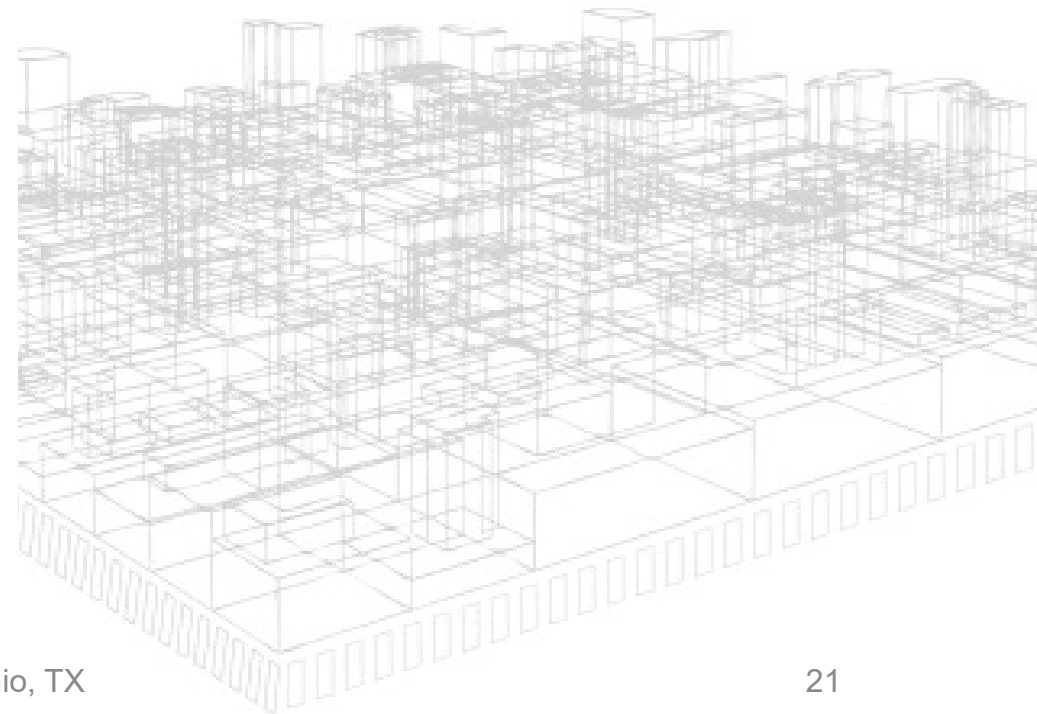

Actual Fan Electrical Input Power (FEP_{act})

Flexible coupling power transmission

- The efficiency of a flexible shaft coupling is:

$$\eta_B = 0.98$$

No power transmission

- If the motor shaft is rigidly connected to the fan impeller, the

$$\eta_B = 1$$

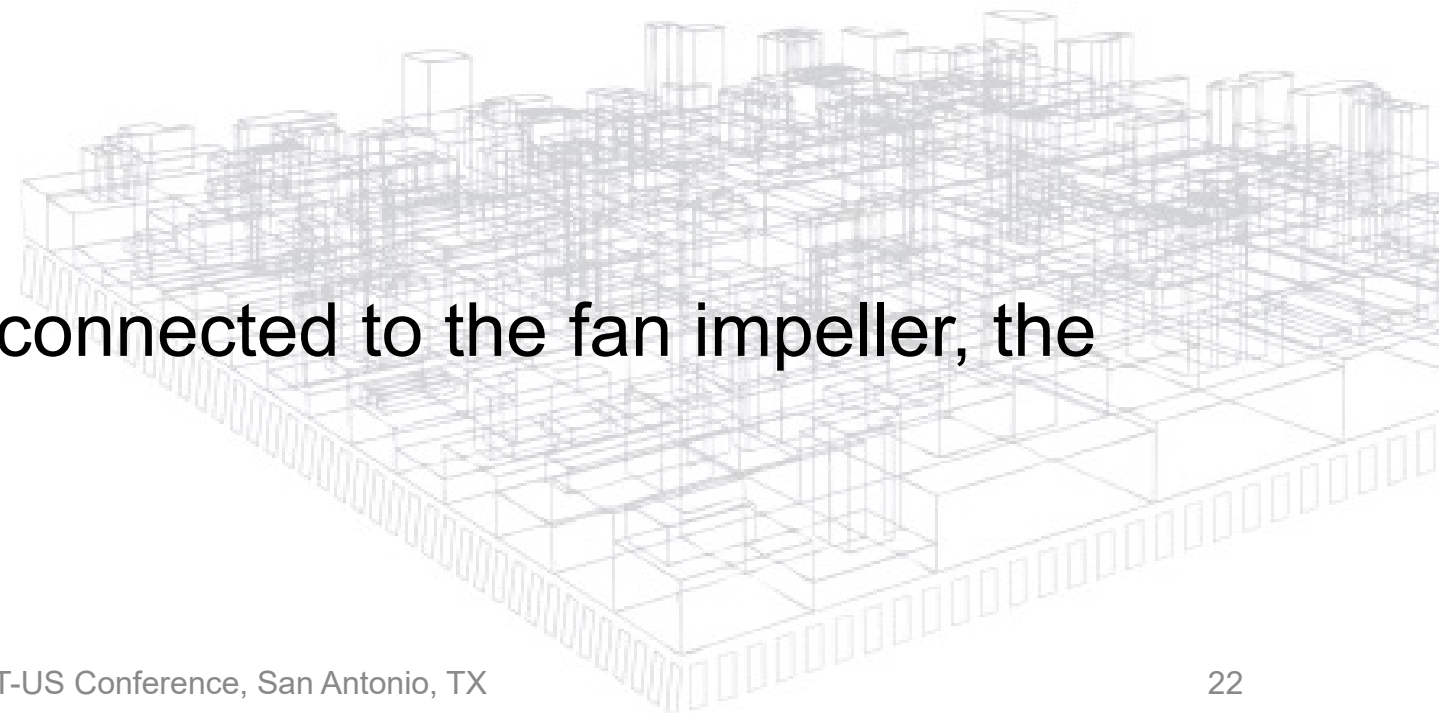

Actual Fan Electrical Input Power (FEP_{act})

The motor and VFD efficiencies are combined into a single value.

Steps to determine motor/vfd combined efficiency:

1. Determine the motor output power (H_m)
2. Calculate motor load ratio (L_m)
3. Determine the motor efficiency (η_m)
4. Determine the control (VFD) load ratio (L_c)
5. Determine the motor and VFD efficiency (η_{mc})
6. Determine the motor input power (W_c)

Actual Fan Electrical Input Power (FEP_{act})

The motor and VFD efficiencies are combined into a single value.

Steps to determine motor/vfd combined efficiency:

1. Determine motor output power

$$H_m = \frac{H_i}{\eta_B}$$

where H_i is the fan input power and η_B is the transmission efficiency calculated from earlier.

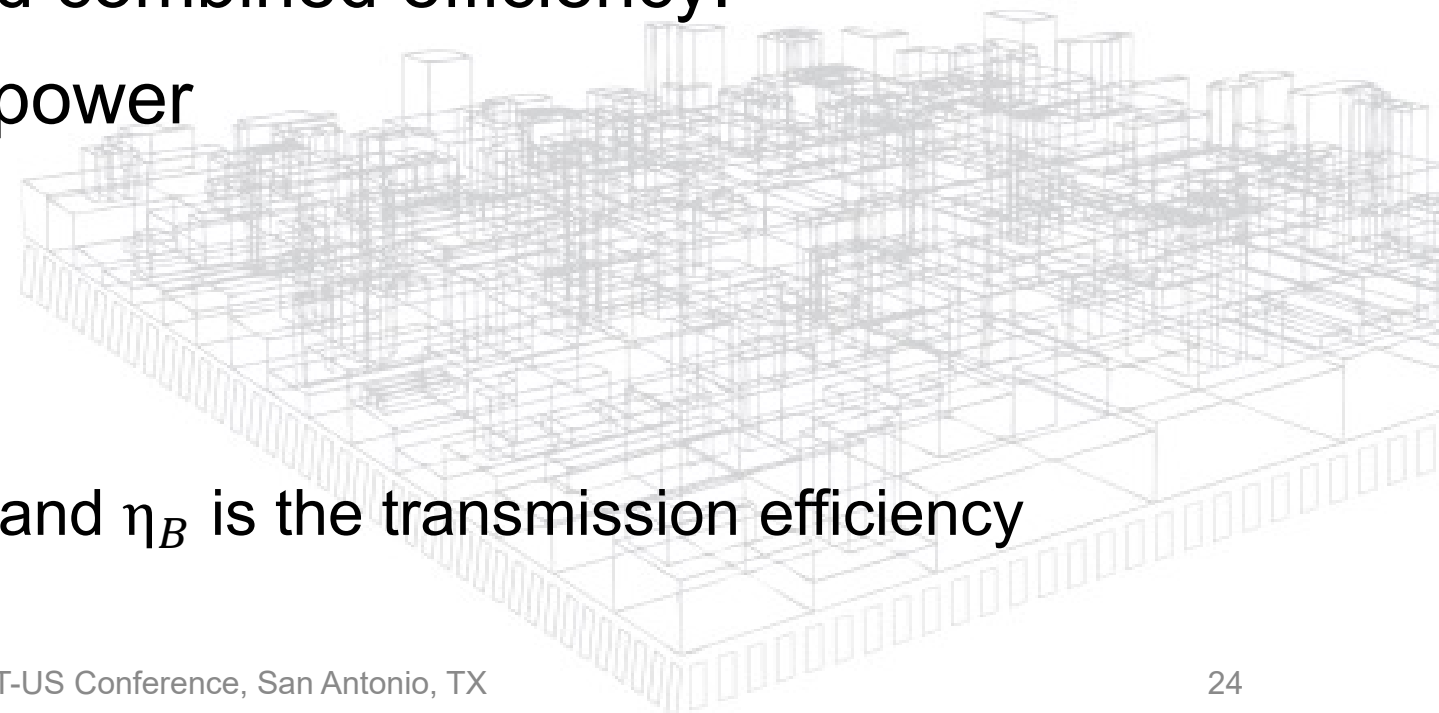

Actual Fan Electrical Input Power (FEP_{act})

The motor and VFD efficiencies are combined into a single value.

Steps to determine motor/vfd combined efficiency:

1. Determine motor output power
2. Determine the motor load ratio

H_m = motor output power

H_{mo} = nameplate output power

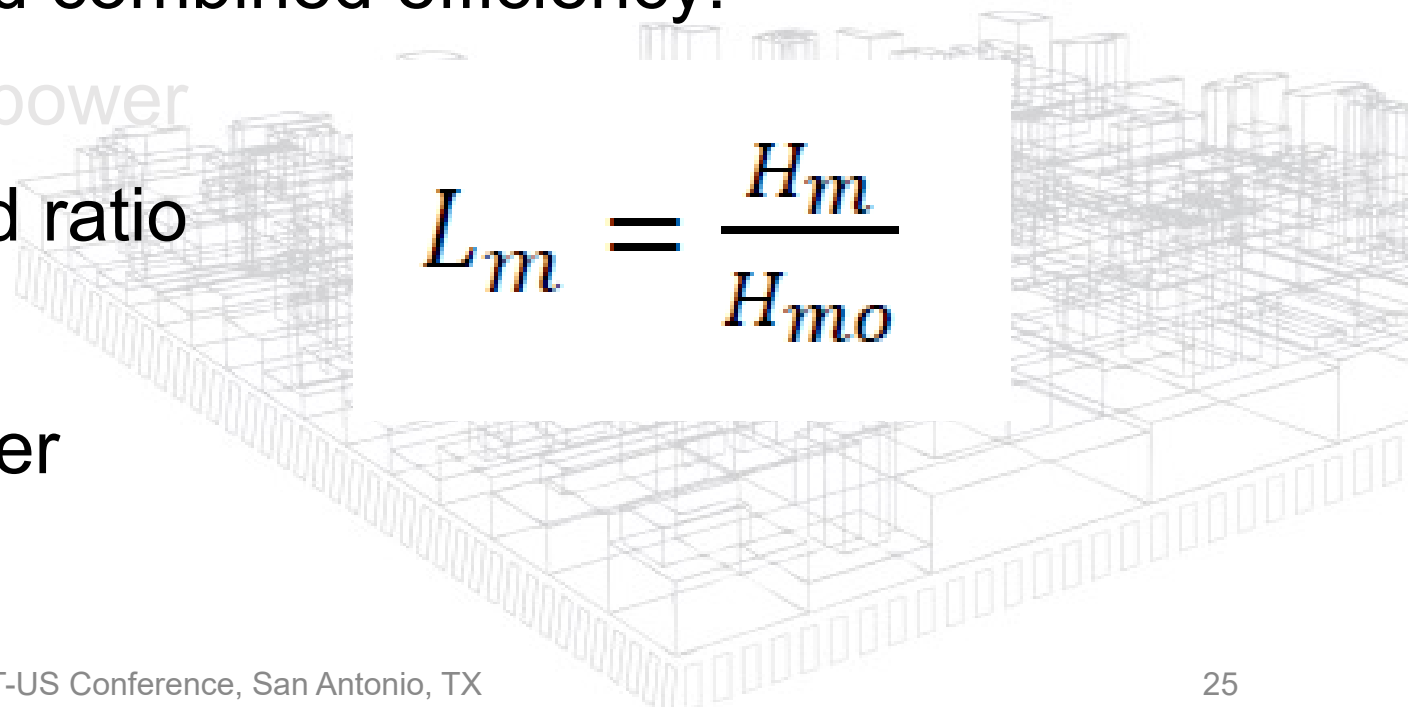
$$L_m = \frac{H_m}{H_{mo}}$$

Actual Fan Electrical Input Power (FEP_{act})

The motor and VFD efficiencies are combined into a single value.

Steps to determine motor/vfd combined efficiency:

1. Determine the motor output power
2. Calculate motor load ratio
3. Determine the motor efficiency

η_m is the Nominal motor efficiency

η_R is the Nominal regulated efficiency

L_m is the motor load ratio



$$\eta_m = \eta_R \left(\frac{aL_m}{b + L_m} + cL_m^2 \right)$$

Table A1. EPCA Nominal Motor Efficiency (60 Hz motors)

Motor Power/Standard Kilowatt Equivalent	ODP				TEFC			
	2 POLE	4 POLE	6 POLE	8 POLE	2 POLE	4 POLE	6 POLE	8 POLE
1/7.5	77.0	85.5	82.5	75.5	77.0	85.5	82.5	72.0
1.5/1.1	84.0	86.5	86.5	77.0	84.0	86.5	87.5	75.5
2/1.5	85.5	86.5	87.5	86.5	85.5	86.5	88.5	81.5
3/2.2	85.5	89.5	88.5	87.5	86.5	89.5	89.5	82.5
5/3.7	86.5	89.5	89.5	88.5	88.5	89.5	89.5	84.0
7.5/5.5	88.5	91.0	90.2	89.5	89.5	91.7	91.0	84.0
10/7.5	89.5	91.7	91.7	90.2	90.2	91.7	91.0	87.5
15/11	90.2	93.0	91.7	90.2	91.0	92.4	91.7	87.5
20/15	91.0	93.0	92.4	91.0	91.0	93.0	91.7	88.5
25/18.5	91.7	93.6	93.0	91.0	91.7	93.6	93.0	88.5
30/22	91.7	94.1	93.6	91.7	91.7	93.6	93.0	90.2
40/30	92.4	94.1	94.1	91.7	92.4	94.1	94.1	90.2
50/37	93.0	94.5	94.1	92.4	93.0	94.5	94.1	91.0
60/45	93.6	95.0	94.5	93.0	93.6	95.0	94.5	91.0
75/55	93.6	95.0	94.5	94.1	93.6	95.4	94.5	92.4
100/75	93.6	95.4	95.0	94.1	94.1	95.4	95.0	92.4
125/90	94.1	95.4	95.0	94.1	95.0	95.4	95.0	93.0
150/110	94.1	95.8	95.4	94.1	95.0	95.8	95.8	93.0
200/150	95.0	95.8	95.4	94.1	95.4	96.2	95.8	93.6
250/186	95.0	95.8	95.4	95.0	95.8	96.2	95.8	94.1
300/224	95.4	95.8			95.8	96.2		

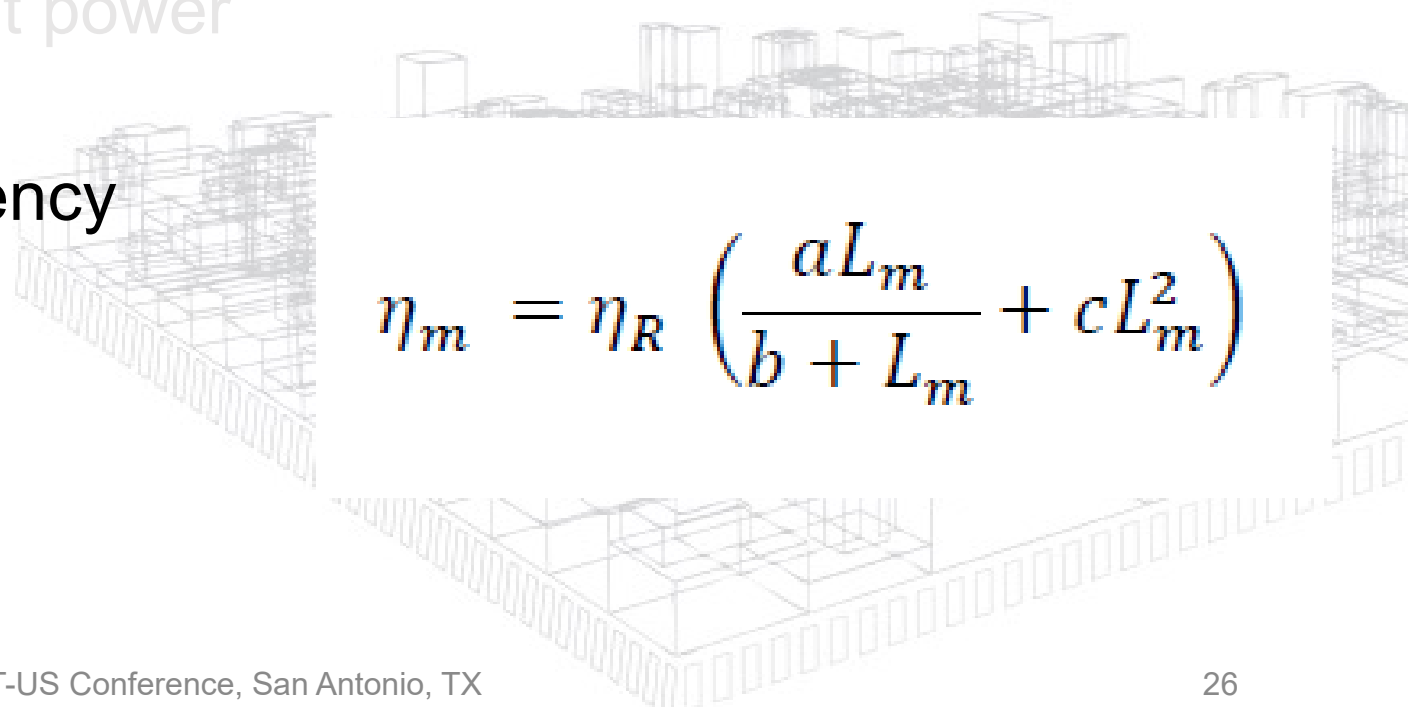

Table D1. Polyphase Induction Motor Performance Constants (DOL, hp rated motors)

HP	2 POLE		4 POLE		6 & 8 POLE	
	<i>a</i>	<i>b</i>	<i>a</i>	<i>b</i>	<i>a</i>	<i>b</i>
1	1.13460	0.08674	1.12541	0.09132	1.16873	0.11466
1.5	1.12932	0.08114	1.12067	0.08492	1.15895	0.10606
2	1.12405	0.07555	1.11592	0.07851	1.14917	0.09747
3	1.11350	0.06436	1.10643	0.06571	1.12962	0.08027
5	1.09241	0.04197	1.08745	0.04009	1.09051	0.04588
7.5	1.08883	0.03990	1.08340	0.03745	1.08579	0.04217
10	1.08526	0.03783	1.07936	0.03481	1.08107	0.03846
15	1.07811	0.03368	1.07127	0.02953	1.07163	0.03104
20	1.07096	0.02953	1.06318	0.02425	1.06218	0.02362
25	1.06949	0.02923	1.06033	0.02291	1.05966	0.02257
30	1.06802	0.02892	1.05749	0.02157	1.05713	0.02152
40	1.06508	0.02831	1.05180	0.01889	1.05208	0.01942
50	1.06214	0.02769	1.04612	0.01621	1.04703	0.01732
60	1.05946	0.02585	1.04436	0.01556	1.04553	0.01691
75	1.05544	0.02309	1.04172	0.01459	1.04328	0.01631
100	1.04874	0.01849	1.03732	0.01298	1.03954	0.01530
125	1.04713	0.01813	1.03731	0.01332	1.03948	0.01463
150	1.04553	0.01778	1.03729	0.01365	1.03942	0.01396
200	1.04231	0.01707	1.03726	0.01432	1.03931	0.01262
250	1.04231	0.01707	1.03726	0.01432	1.03931	0.01262
300	1.04231	0.01707	1.03726	0.01432	1.03931	0.01262
350	1.04231	0.01707	1.03726	0.01432	1.03931	0.01262

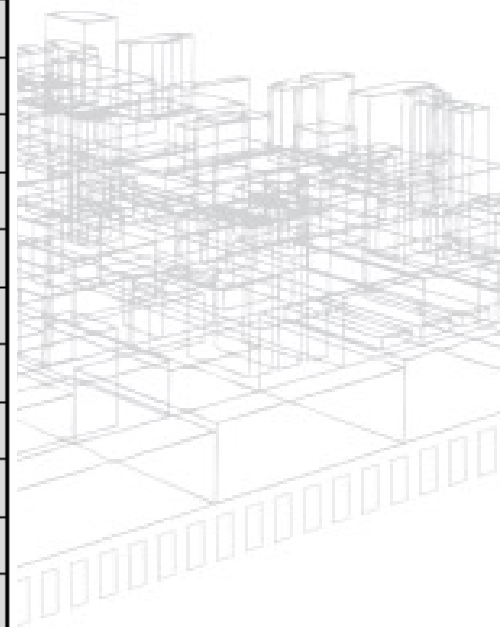

Actual Fan Electrical Input Power (FEP_{act})

The motor and VFD efficiencies are combined into a single value.

Steps to determine motor/vfd combined efficiency:

1. Determine the motor output power
2. Calculate motor load ratio
3. Determine the motor efficiency
4. Determine the control (VFD) load ratio

$$L_c = \frac{H_m}{\eta_m H_{co}}$$

where H_{co} is the output capacity of the VFD.

Actual Fan Electrical Input Power (FEP_{act})

The motor and VFD efficiencies are combined into a single value.

Steps to determine motor/vfd combined efficiency:

1. Determine the motor output power
2. Calculate motor load ratio
3. Determine the motor efficiency
4. Determine the control (VFD) load
5. Determine the motor and VFD efficiency

$$\eta_{mc} = \eta_m \left(\frac{dL_c}{e + L_c} + fL_c \right)$$

C1. VFD Performance Constants (hp capacity)

HP	<i>d</i>	<i>e</i>	<i>f</i>
1	0.98030	0.04000	-0.01310
1.5	0.97995	0.03855	-0.01180
2	0.97960	0.03710	-0.01050
3	0.97890	0.03420	-0.00790
5	0.97750	0.02840	-0.00270
7.5	0.97810	0.02530	-0.00040
10	0.97870	0.02220	0.00190
15	0.98185	0.01985	0.00070
20	0.98500	0.01750	-0.00050
25	0.98620	0.01650	-0.00320
30	0.98740	0.01550	-0.00590
40	0.98765	0.01695	-0.00380
50	0.98790	0.01840	-0.00170
60	0.97190	0.01450	0.01180
75	0.99190	0.01790	-0.00130
100	0.98240	0.01260	0.00140
125	0.98293	0.01190	-0.00010
150	0.98345	0.01120	-0.00160
200	0.98450	0.00980	-0.00460

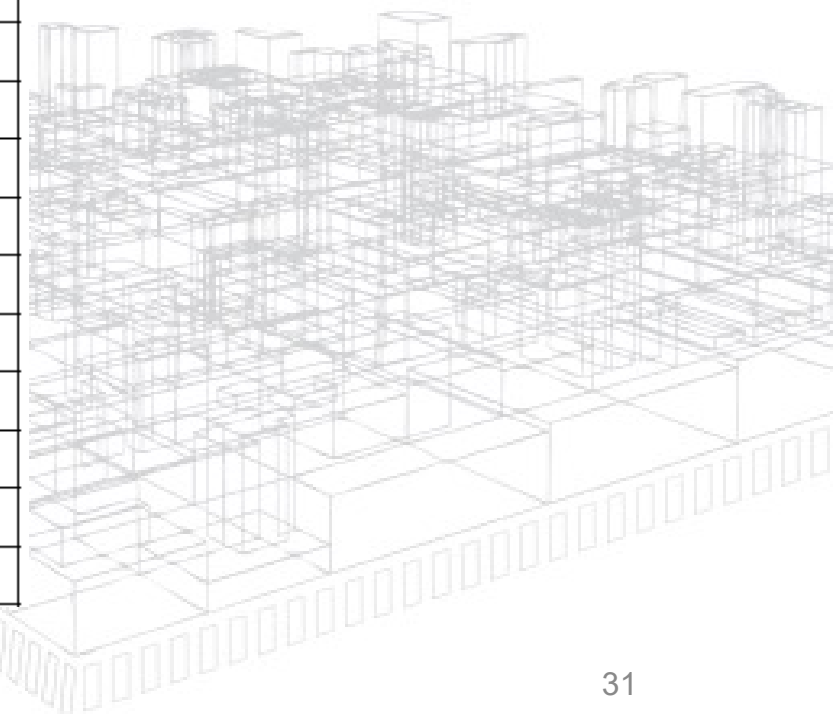

System integration - (FEP_{act})

The fan **system input power in kW** for combined motor and **VFD** operation is calculated by:

1. Determine the motor output power
2. Calculate motor load ratio
3. Determine the motor efficiency
4. Determine the control (VFD) load
5. Determine the motor and VFD efficiency
6. Determine the motor input power

$$W_c = \frac{.746H_i}{\eta_{mc}\eta_B}$$

Where:

η_{mc} = Combined motor and VFD efficiency

η_B = transmission efficiency

System integration - (FEP_{act})

Overall fan **system power input** and efficiency are determined by combining results for the fan system components.

The fan system **input power in kW for DOL** motor operation is calculated by:

$$W_c = \frac{.746H_i}{\eta_m \eta_B}$$

Where:

η_m = motor efficiency

η_B = transmission efficiency

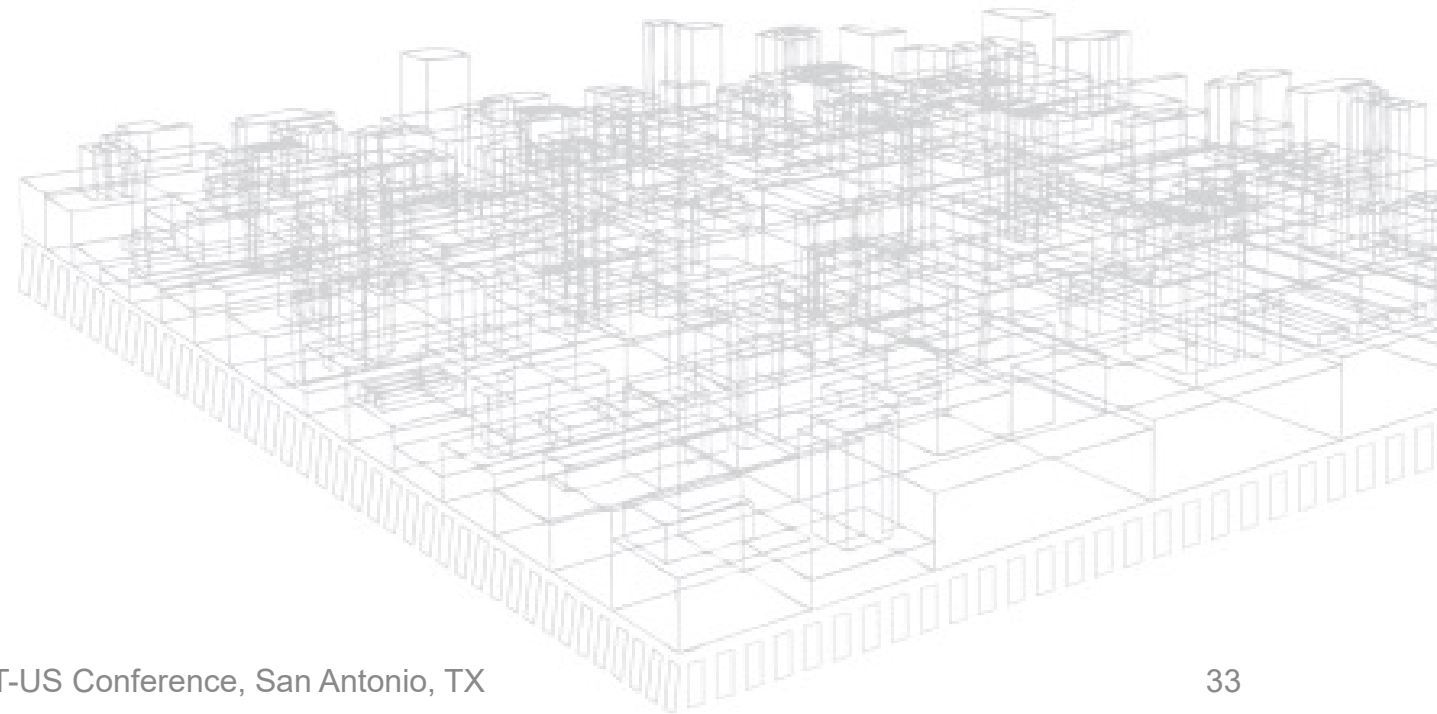

FEI Range for Centrifugal with Speed Control

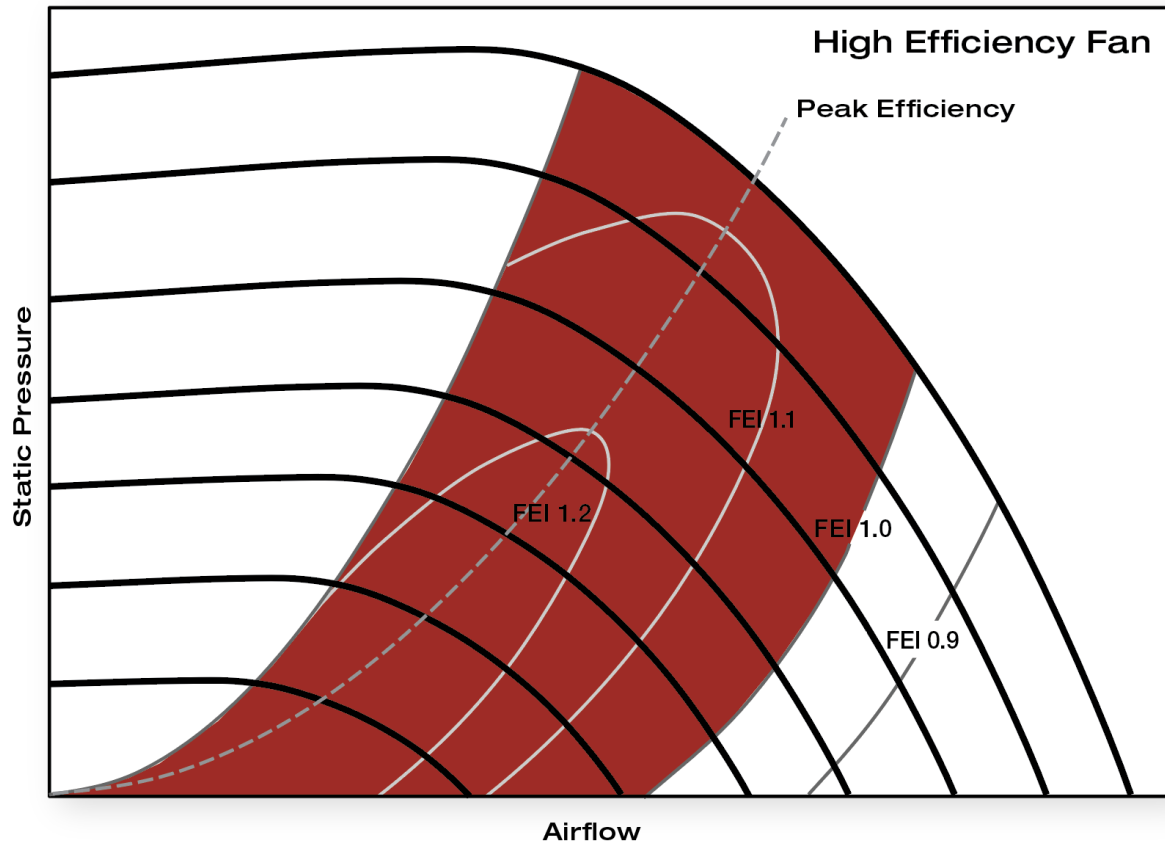

EFFICIENT FAN

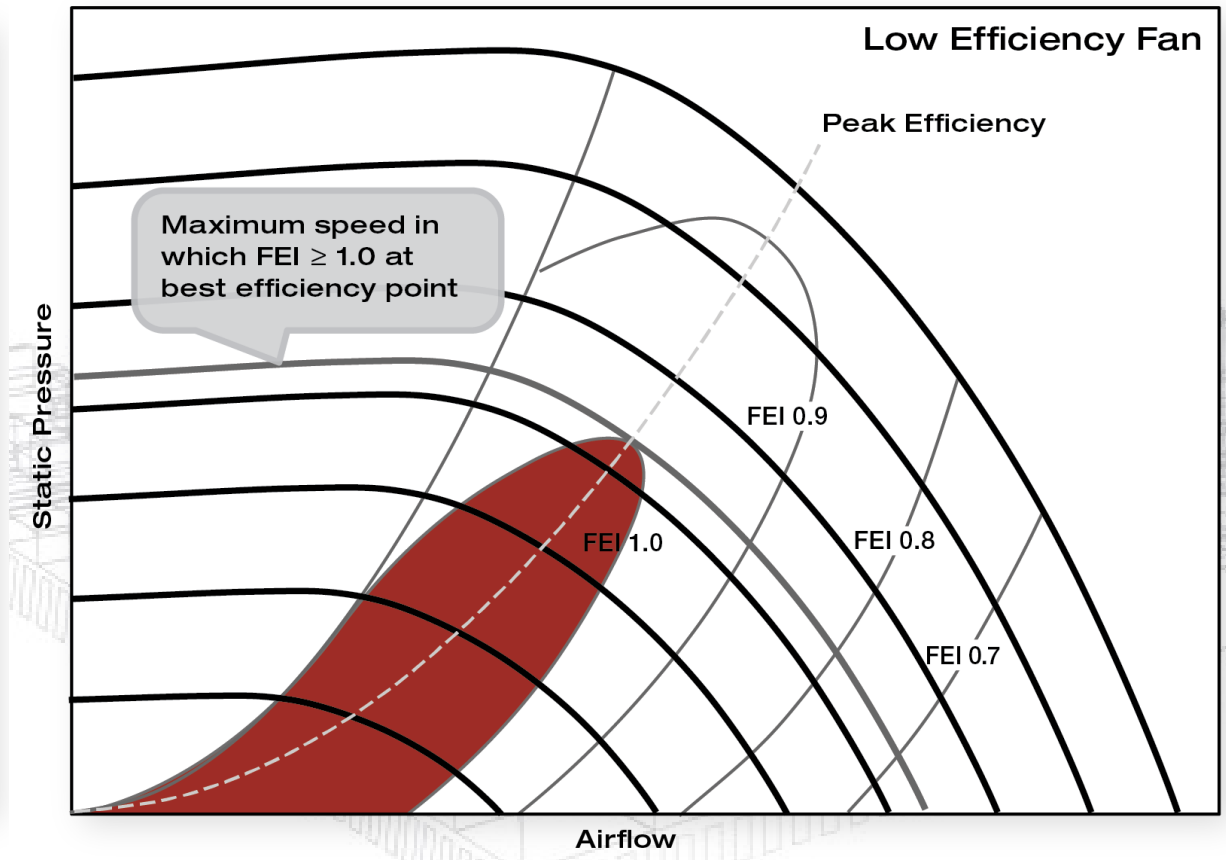

INEFFICIENT FAN

FEI Range for Adjustable Pitch Axial

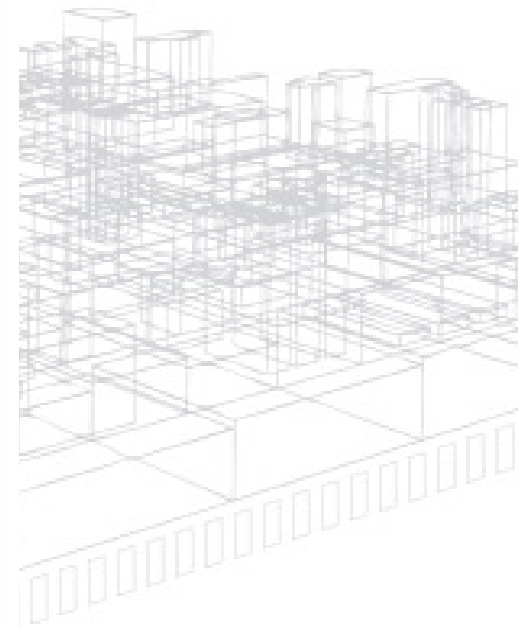
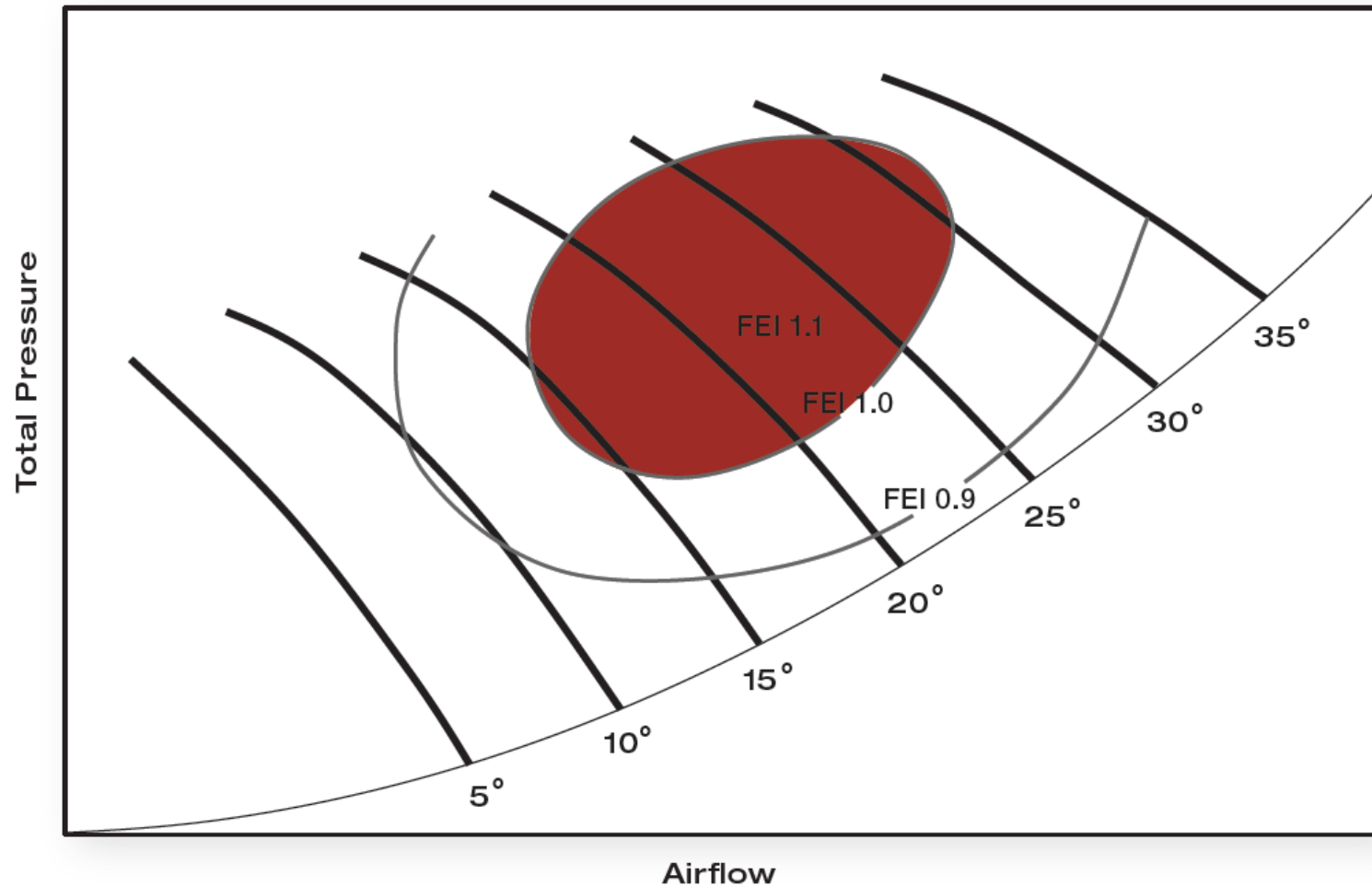

Worked example for a housed centrifugal fan with belt transmission operating DOL

A housed centrifugal fan is selected to deliver 5.94 m³/s (12,000 cfm) at a fan total pressure of 1250 Pa (5 in. wg). The input power to the fan, H_i , is 15.8 kW (11.8 hp) and fan speed is 1500 rpm. The fan is driven through a V-belt transmission with a 15 hp, four-pole ODP premium efficiency motor regulated under EISA 2007.

Worked example for a housed centrifugal fan with belt transmission operating DOL

1. Calculate the transmission efficiency

$$\eta_B = 0.96 \left(\frac{H_i}{H_i + 2.2} \right)^{0.05} = 0.96 \left(\frac{11.8}{11.8 + 2.2} \right)^{0.05} = 95.2\%$$

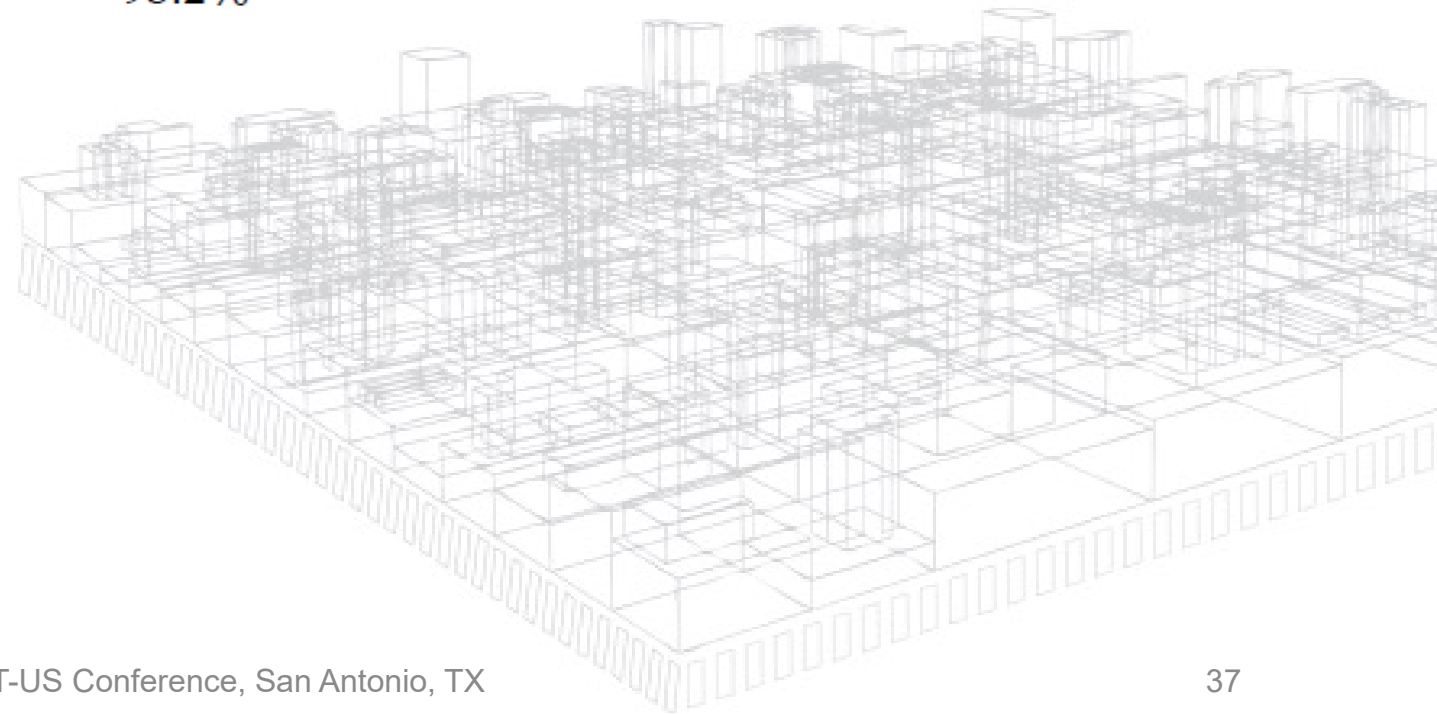

Worked example for a housed centrifugal fan with belt transmission operating DOL

2. Calculate the motor output power

$$H_m = \frac{H_i}{\eta_B} = \frac{11.8}{0.952} = 12.4 \text{ hp (9.3 kW)}$$

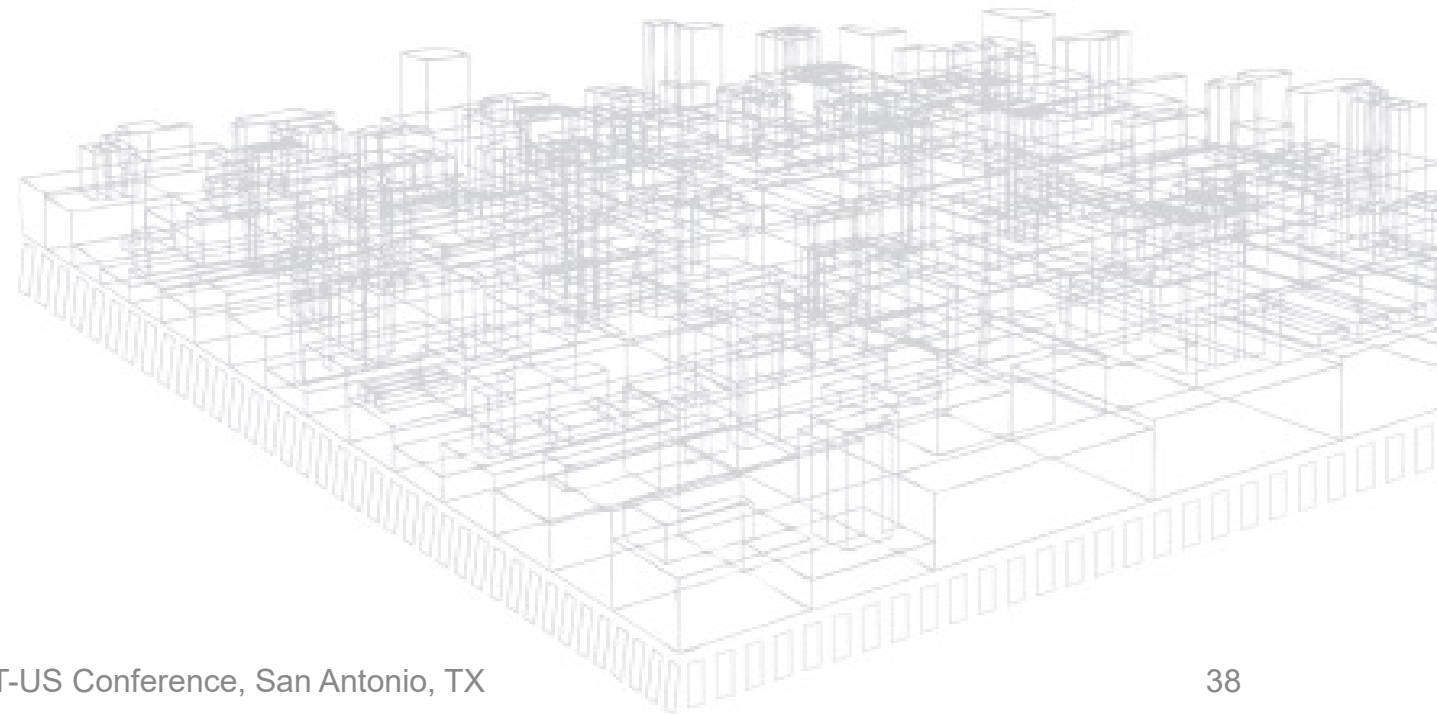

Worked example for a housed centrifugal fan with belt transmission operating DOL

3. Calculate the motor load ratio

$$L_m = \frac{H_m}{H_{mo}} = \frac{12.4}{15.0} = 0.827$$

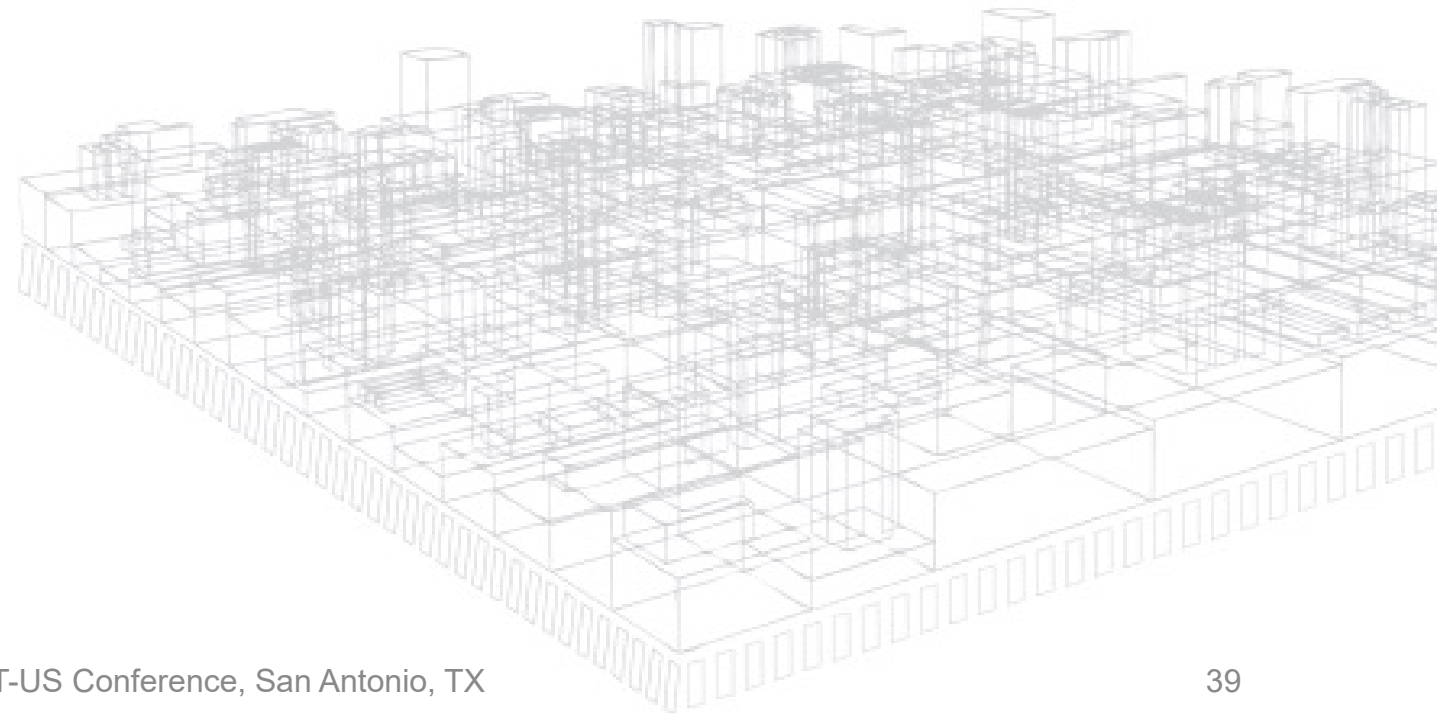

Worked example for a housed centrifugal fan with belt transmission operating DOL

4. Calculate the motor efficiency, η_m . Obtain the motor nominal efficiency, η_R , from Table A1 and the motor performance constants, a and b , from Table D1. The constant c is calculated from a and b .

$$c = 1 - \frac{a}{b + 1}$$

$$\eta_m = \eta_R \left(\frac{aL_m}{b + L_m} + cL_m^2 \right) = 0.93 \left(\frac{1.07127 \cdot 0.827}{0.02953 + 0.827} + (-0.0405)(0.827)^2 \right) = 93.6\%$$

The motor input power is then calculated as

$$W_c = \frac{0.746 H_i}{\eta_m \eta_B} = \frac{0.746 \cdot 11.8}{0.936 \cdot 0.952} = 9.9 \text{ kW}$$

Worked example for a housed centrifugal fan with belt transmission operating DOL

4. Calculate the motor/VFD efficiency. Obtain the VFD constants d , e , and f from Table C1.

$$c = 1 - \frac{a}{b + 1}$$

$$\eta_m = \eta_R \left(\frac{aL_m}{b + L_m} + cL_m^2 \right) = 0.93 \left(\frac{1.07127 \cdot 0.827}{0.02953 + 0.827} + (-0.0405)(0.827)^2 \right) = 93.6\%$$

The motor input power is then calculated as

$$W_c = \frac{0.746 H_i}{\eta_m \eta_B} = \frac{0.746 \cdot 11.8}{0.936 \cdot 0.952} = 9.9 \text{ kW}$$

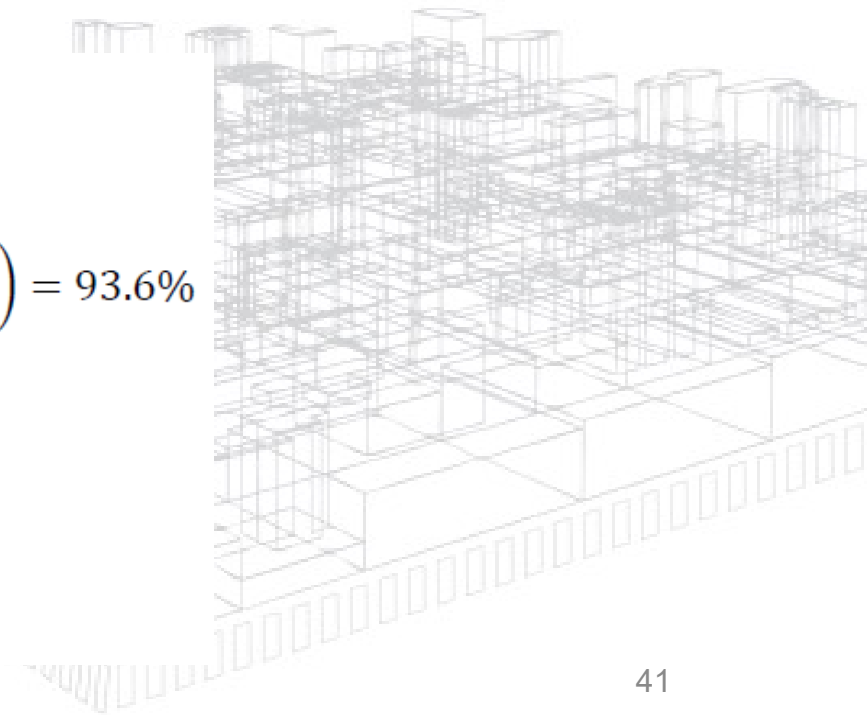

Status

- AMCA Standard 208 is published
- AMCA 208 is integrated into ISO 12759
- Default losses for drive components based on AMCA 207
- FEI would be calculated using rating data taken during AMCA 210 or ISO 5801 tests
- U.S. DOE regulation stalled, but would be based on FEI
- California stated regulation picking up where DOE left off
- ASHRAE 90.1 replacing FEG with FEI
- U.S. efficiency rebates will be based on FEI

Resources

- AMCA International: www.amca.org
- AMCA Standards Bookstore: www.amca.org/store



Questions?

Trinity Persful

VP Marketing

Twin City Fan Company

tpersful@tcf.com

